

National Land and Water Resources Audit
Theme 1-Water Availability

Extension of Unimpaired Monthly Streamflow
Data and Regionalisation of Parameter Values to
Estimate Streamflow in Ungauged Catchments

Centre for Environmental Applied Hydrology
The University of Melbourne

Murray C. Peel

Francis H.S. Chiew

Andrew W. Western

Thomas A. McMahon

July 2000

Summary

This project is carried out by the Centre for Environmental Applied Hydrology at the University of Melbourne as part of the National Land and Water Resources Audit Project 1 in Theme 1 (Water Availability). The objectives of the project are to extend unimpaired streamflow data for stations throughout Australia and to relate the model parameters to measurable catchment characteristics. The long time series of streamflow data are important for both research and management of Australia's hydrological and ecological systems.

A simple conceptual daily rainfall-runoff model, SIMHYD, is used to extend the streamflow data. The model estimates streamflow from daily rainfall and areal potential evapotranspiration data. The parameters in the model are first calibrated against the available historical streamflow data. The optimised parameter values are then used to estimate monthly streamflow from 1901-1998.

The modelling is carried out on 331 catchments across Australia, most of them located in the more populated and important agricultural areas in eastern and south-east Australia. These catchments are unimpaired, have at least 10 years of streamflow data and catchment areas between 50 km² and 2000 km².

The model calibration and cross-validation analyses carried out in this project indicate that SIMHYD can estimate monthly streamflow satisfactorily for most of the catchments. The streamflow simulations are considered to be good in 111 catchments, satisfactory in 123 catchments, passable in 52 catchments and poor in 45 catchments. The streamflow data are only extended for catchments with simulations that are considered passable or better.

The main outcome of this project is therefore time series of estimated monthly streamflow data from 1901-1998 for 286 catchments in Australia.

The relationship between the optimised model parameter values and climate, relief and soil characteristics are also investigated. The results indicate that there is a high statistical significance between some of the model parameters and the catchment characteristics. These relationships will be explored further in a more detailed analysis with a view to developing relationships between model parameters and catchment characteristics that can be used in ungauged catchments.

1. Introduction

This project is carried out by the Centre for Environmental Applied Hydrology at the University of Melbourne as part of the National Land and Water Resources Audit Project 1 in Theme 1 – Water Availability.

The objectives of this project are to extend streamflow data for stations throughout Australia and to relate the rainfall-runoff model parameters against measurable catchment characteristics. The main outcome of this project is long time series monthly streamflow data (1901-1998) for 286 catchments across Australia. The long time series data are important for both research and management of Australia's hydrological and ecological systems. Specific benefits include

- long continuous records, providing better understanding of the inter-annual variability of streamflow characteristics throughout Australia,
- long records allow better characterisation of streamflow and the distribution of streamflow values (mean volume and high and low flow characteristics),
- long records allow the assessment of changes (climate change impact or otherwise) in various streamflow characteristics over the last century (e.g., mean annual and seasonal runoff volume, peak flow, hydrological drought or storage deficit, inter-annual variability, etc ...),
- long continuous data provide a better understanding of the relationship between streamflow and El Nino/Southern Oscillation (ENSO), leading to improved methods for forecasting streamflow several months in advance, and
- the streamflow datasets will allow direct comparison of pre-regulated and regulated conditions over the same time periods (where appropriate).

Successful regionalisation of the rainfall-runoff model parameters against measurable catchment characteristics would enable streamflow from ungauged catchments to be estimated. The regionalised model could then be used to estimate Australia's total and potential water resources.

2. Method

The steps in the methodology used to extend unimpaired monthly streamflow records are

- select unimpaired catchments for monthly streamflow extension,
- collate daily precipitation, monthly areal potential evapotranspiration and monthly streamflow data for each catchment,
- calibrate the daily rainfall-runoff model SIMHYD against the recorded streamflow data, and
- use the calibrated parameters values in the rainfall-runoff model to extend the monthly streamflow from 1901 – 1998.

2.1. Catchment selection

The catchments included in this project must have at least 10 years (120 months) of unimpaired streamflow data and a catchment area between 50 and 2000 km².

Unimpaired or natural streamflow is defined as streamflow that is not subject to regulation or diversion. Unimpaired streamflow data are requested from the relevant federal, state and territory agencies. Each station is checked for regulation using the list of dams provided in Boughton (1999). Monthly streamflow datasets with missing months are allowed so long as the basic requirement of 120 months of recorded data is satisfied.

The catchment area limits of 50 – 2000 km² is used so that the lumped daily rainfall used for the modelling has similar meaning and the optimised model parameter values can be compared across catchments.

In order to avoid modelling the same data several times nested catchments (where a catchment is a sub-catchment of another catchment) are removed according to the following rule. When a catchment has greater than 20% of its area represented by another catchment(s), then the sub-catchment(s) are used, while the initial catchment is not used.

The 331 gauging stations used are listed along with some catchment characteristics, by state and territory, in Appendix 1 and their location is shown in Figure 2.1. The stations in Appendix 1 are not all the Australian stations that fit the above criteria, rather they are all of the stations that were provided to us by the various federal, state and territory agencies, which fit the above criteria.

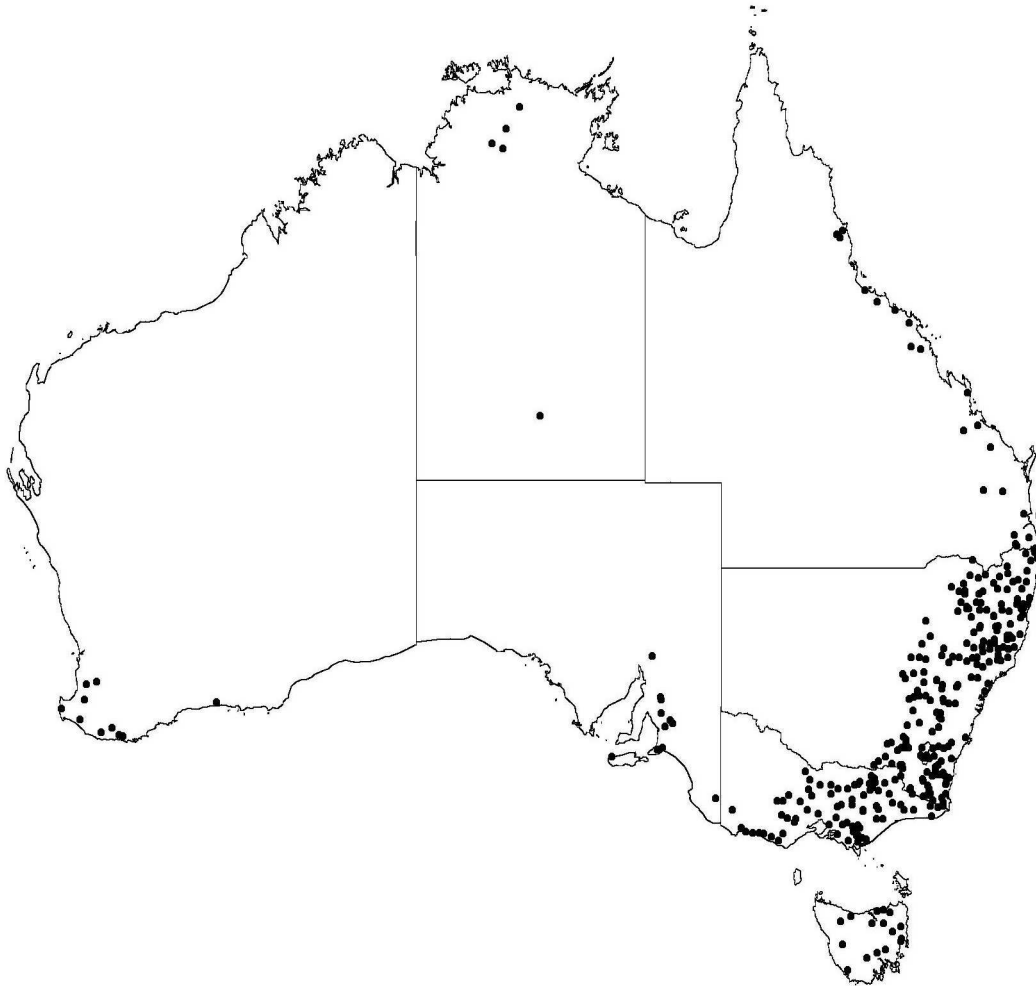

Figure 2.1. Locations of 331 catchments used in this project.

An initial set of monthly streamflow data for the whole of Australia are obtained from data collated by Ross James (Australian Bureau of Meteorology) as part of the LWRDC project on seasonal streamflow forecasting to improve the management of water resources. Extra data for Victoria are provided by Nathan & Weinmann (1993), Tasmania by the Department of Primary Industries, Water and Environment (DPIWE, 2000), South Australia by the Department for Environment and Aboriginal Affairs, Environment Protection Agency (DEHAA, 2000) and New South Wales by the Department of Land and Water Conservation (DLWC, 1999).

Quality codes for the streamflow data are provided by the relevant federal, state and territory agencies. In general, the data are included for use when the quality rating is fair or better. Data quality rated as modelled, poor or unverified are generally not included.

2.2. Rainfall-runoff model

A simplified version of the conceptual daily rainfall-runoff model HYDROLOG (SIMHYD) is used to simulate and extend streamflow records. Variants of HYDROLOG have been used extensively in Australia for various applications (see Porter and McMahon, 1975, 1976; Chiew and McMahon, 1994; and Chiew et al., 1993, 1995, 1996, 2000).

The structure of SIMHYD is shown in Figure 2.2 with its seven parameters highlighted in bold italics.

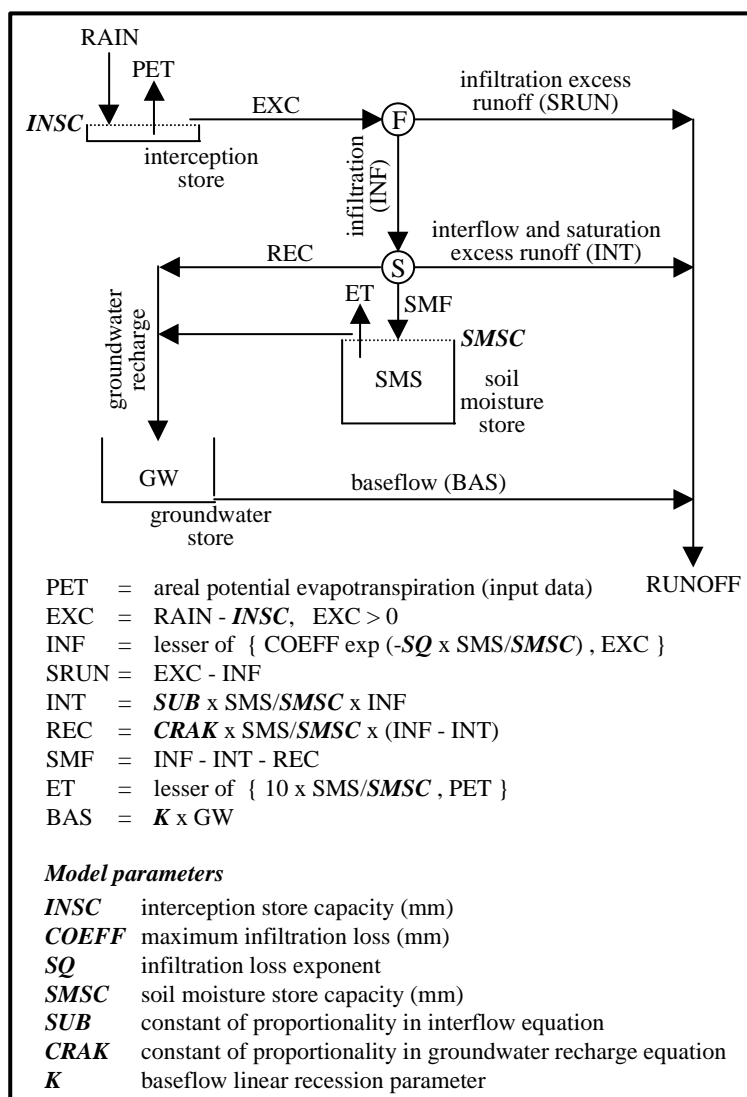

Figure 2.2. Structure of the conceptual rainfall-runoff model SIMHYD

In SIMHYD, daily rainfall first fills the interception store, which is emptied each day by evaporation. The excess rainfall is then subjected to an infiltration function that determines the infiltration capacity. The excess rainfall that exceeds the infiltration capacity becomes infiltration excess runoff.

Moisture that infiltrates is subjected to a soil moisture function that diverts the water to the stream (interflow), groundwater store (recharge) and soil moisture store. Interflow is first estimated as a linear function of the soil wetness (soil moisture level divided by soil moisture capacity). The equation used to simulate interflow therefore attempts to mimic both the interflow and saturation excess runoff processes (with the soil wetness used to reflect parts of the catchment that are saturated from which saturation excess runoff can occur). Groundwater recharge is then estimated, also as a linear function of the soil wetness. The remaining moisture flows into the soil moisture store.

Evapotranspiration from the soil moisture store is estimated as a linear function of the soil wetness, but cannot exceed the atmospherically controlled rate of areal potential evapotranspiration. The soil moisture store has a finite capacity and overflows into the groundwater store. Baseflow from the groundwater store is simulated as a linear recession from the store.

The model therefore estimates runoff generation from three sources – infiltration excess runoff, interflow (and saturation excess runoff) and baseflow. The routing of streamflow is not considered in this study. Nevertheless, like HYDROLOG, streamflow routing can also be simulated in SIMHYD with the use of two more parameters.

2.3. Data collation and analysis

Daily rainfall, monthly areal potential evapotranspiration, monthly streamflow and catchment boundaries are required for this project. The catchment area location in space is required in order to use gridded values of rainfall and areal potential evapotranspiration.

Continuous daily rainfall data are required to operate the daily rainfall-runoff model. Gridded daily rainfall data are provided by the Queensland Department of Natural Resources (see <http://www.dnr.qld.gov.au/silo>). The spatial resolution of the gridded daily rainfall is 5 km x 5 km based on interpolation of over 6000 rainfall stations in Australia. The interpolation uses monthly rainfall data, Ordinary Krigging with zero nugget and a variable range. Monthly rainfall for each 5 km x 5 km point is converted to daily rainfall by using the daily rainfall distribution from the station closest to that point. The lumped catchment-averaged daily rainfall used in SIMHYD is estimated from the daily rainfall in 5 km x 5 km points within the catchment.

The inter-annual variability of potential evapotranspiration is relatively small (typically coefficient of variation < 0.05). For this reason, the mean monthly areal potential evapotranspiration is used. The 12 mean monthly areal potential evapotranspiration values are obtained from the evapotranspiration maps produced jointly by the Cooperative Research Centre for Catchment Hydrology and the Australian Bureau of Meteorology (see Wang et al., 2000). The areal evapotranspiration values are derived using the wet environment evapotranspiration algorithms proposed by Morton (1983).

Digitised catchment boundaries were provided by Nathan & Weinmann (1993) for Victoria, DPIWE (2000) for Tasmania and DEHAA (2000) for South Australia. All other catchment boundaries were digitised by hand from the NATMAP 1:100,000 map series.

2.4. Calibration and cross validation of SIMHYD

The methods of calibration and cross validation of SIMHYD are outlined in this section. The calibration is conducted to assess whether SIMHYD can be calibrated successfully. The cross-validation is conducted to assess whether the calibrated parameter values can be used to successfully estimate streamflow for an independent test period that is not used to calibrate the model.

SIMHYD is run on a daily time step but the model is calibrated against monthly streamflow. In order for model stores to be in equilibrium before calibration statistics are calculated the model is run for a year prior to the first year to be calibrated.

The entire recorded monthly runoff record is used to calibrate SIMHYD. The seven model parameters are optimized to reduce an objective function defined as the sum of squared differences between the estimated and recorded monthly streamflows (Equation 1).

$$OBJ = \sum_{i=1}^n (EST_i - REC_i)^2 \quad (1)$$

where OBJ is the objective function, EST is the estimated monthly streamflow, REC is the recorded monthly streamflow and n is the number of months of recorded monthly streamflow.

Since the calibrated model is to be used for streamflow record extension, extra effort is made to ensure that the calibrated model is able to reproduce some of the basic summary statistics of the recorded

streamflow. To this end penalties are applied during the calibration process to the objective function if the total estimated monthly streamflow or estimated annual coefficient of variation differed from the recorded values as outlined below.

- If the total estimated and total recorded monthly streamflow differ by;
 - More than 5% then OBJ = OBJ x 5
 - More than 10% then OBJ = OBJ x 25
 - More than 20% then OBJ = OBJ x 125
- If the estimated and recorded annual coefficient of variation differ by;
 - More than 5% then OBJ = OBJ x 5
 - More than 10% then OBJ = OBJ x 25
 - More than 20% then OBJ = OBJ x 125

The total monthly streamflow penalty is designed to ensure that the total estimated and recorded streamflows do not differ greatly. In general a good calibration using the objective function described in Equation 1 should produce little difference in the total estimated and recorded monthly streamflow.

The annual coefficient of variation penalty is designed to force the model to reproduce the inter-annual variability of the recorded streamflow. Generally, any calibration using an objective function that minimises the difference between the estimated and recorded streamflows will lead to an estimate of streamflow with lower variability (both inter-annual and seasonal) than that observed. This is due to the objective functions preference for underestimating the higher flows and overestimating the lower flows in order to reduce the errors at both extremes. This penalty is only used where 15 years or more of annual streamflow data are available (200 of the 331 stations) to allow for meaningful interpretation of the coefficient of variation.

An automatic pattern search optimisation method is used to calibrate the model (Hooke & Jeeves, 1961; Monro, 1971), with 10 different parameter sets used as starting points to increase the likelihood of finding the global optimum of parameter values.

The K-fold cross validation method described by Efron & Tibshirani (1993) is used to cross validate the calibrated model. The recorded streamflow is divided into K roughly equal parts (in this case K = 3). SIMHYD is then calibrated against two parts of the recorded streamflow. The calibrated parameters are then used to estimate the streamflow of the remaining part. This process is repeated three times, so that all parts are estimated once. The quality of the calibration can then be verified by comparing the calibration against the cross validation estimated streamflows.

2.5. Monthly streamflow extension

Monthly streamflow data are extended for only catchments that are successfully calibrated and show good cross validation statistics. The criteria for successful calibration and good cross validation is outlined in Section 4. The method for extending monthly streamflow is to use the optimised parameter set derived from calibrating SIMHYD against the entire recorded streamflow to run SIMHYD for the period 1901 to 1998.

3. Modelling Results

3.1. Assessing model performance

Three objective measures are used to assess model performance. The first objective measure of model performance is the coefficient of efficiency (E), presented in Equation 2.

$$E = \frac{\sum_{i=1}^n (REC_i - \overline{REC})^2 - \sum_{i=1}^n (EST_i - REC_i)^2}{\sum_{i=1}^n (REC_i - \overline{REC})^2} \quad (2)$$

where \overline{REC} is the mean recorded streamflow. The coefficient of efficiency describes the proportion of recorded streamflow variance that is described by the model (Nash & Sutcliffe, 1970). If the model exactly reproduced all the recorded monthly streamflow then E would equal 1.0. The coefficient of efficiency is related to the objective function described in Equation 1, in that a low value of the objective function will produce a high value of E and vice versa. The coefficient of efficiency is a dimensionless number, unlike the objective function and is therefore useful for comparisons of model performance across catchments.

The second objective measure of model performance is presented in Equation 3 and is a comparison of total estimated and recorded streamflow as a percentage of the total recorded streamflow (TVOL).

$$TVOL = \frac{\sum_{i=1}^n EST_i - \sum_{i=1}^n REC_i}{\sum_{i=1}^n REC_i} \times 100 \quad (3)$$

The third objective measure of model performance is presented in Equation 4 and is a comparison of the estimated and recorded annual coefficient of variation as a percentage of the recorded coefficient of variation (CV).

$$CV = \frac{\text{annual Cv of est flow} - \text{annual Cv of rec flow}}{\text{annual Cv of rec flow}} \quad (4)$$

3.2. Calibration and cross validation

Calibration and cross validation values of the three objective measures of model performance (E, TVOL and CV) are summarised in Figures 3.1, 3.2 and 3.3 respectively. Direct comparison of the calibration and cross validation is made possible by joining the three cross validation estimates (Section 2.4) together to form a composite cross validation estimate of the complete period of streamflow record.

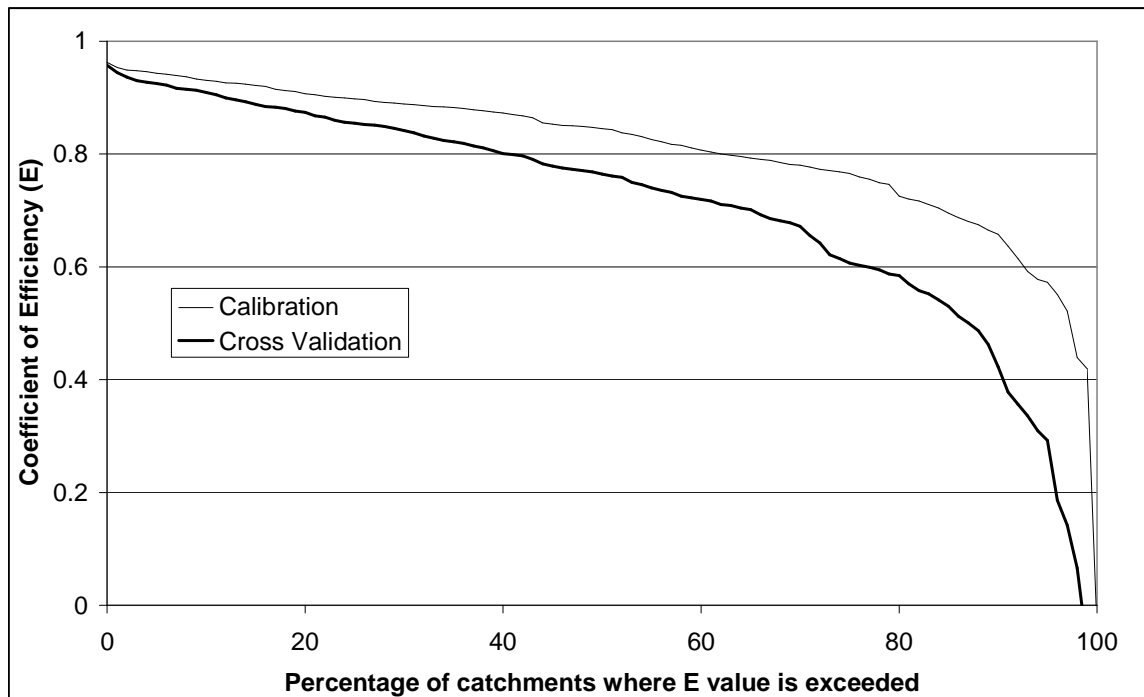

Figure 3.1. Percentage of stations with E values greater than or equal to a given E value.

Figure 3.1 is a plot of the percentage of catchments that have an E value that exceeds a given E value. Less than 3% of the modelled catchments have calibrated E values less than 0.5, which indicates that SIMHYD can be calibrated satisfactorily for almost all Australian catchments. The cross validation E values are lower than the calibration values, as expected. More importantly the cross validation E values, which are an independent test of the quality of the calibration, are consistently high. Cross validation results of $E > 0.42$ for 90% of catchments (considered reasonable), $E > 0.60$ for 76% of catchments (considered satisfactory) and $E > 0.8$ for 40% of catchments (considered good, Chiew & McMahon, 1993) indicate that SIMHYD is generally well cross validated.

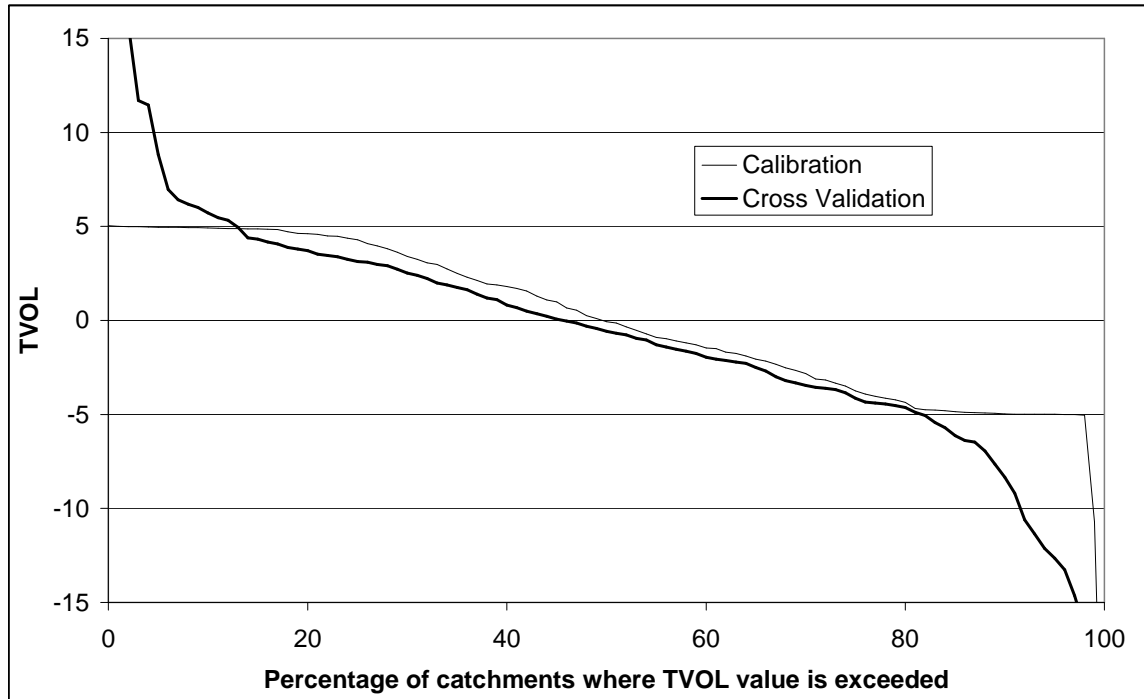

Figure 3.2. Percentage of stations with TVOL values greater than or equal to a given TVOL value.

Figure 3.2 is a plot of the percentage of catchments that have a TVOL value that exceeds a given TVOL value. The calibrated total estimated streamflow is within 5% of the total recorded streamflow for 94% of the catchments modelled, which is expected considering a penalty is applied to the objective function during the calibration process if TVOL is not within 5% (Section 2.4). This result indicates that when calibrated, SIMHYD is able to estimate total streamflow very reliably. The cross validation results indicate that generally the total estimated streamflow volume for the independent test period is similar to the recorded total streamflow. For 95% of catchments the cross validation estimate of total streamflow was within 15% of the recorded total streamflow, for 87% of catchments within 10% and for 68% of catchments within 5%.

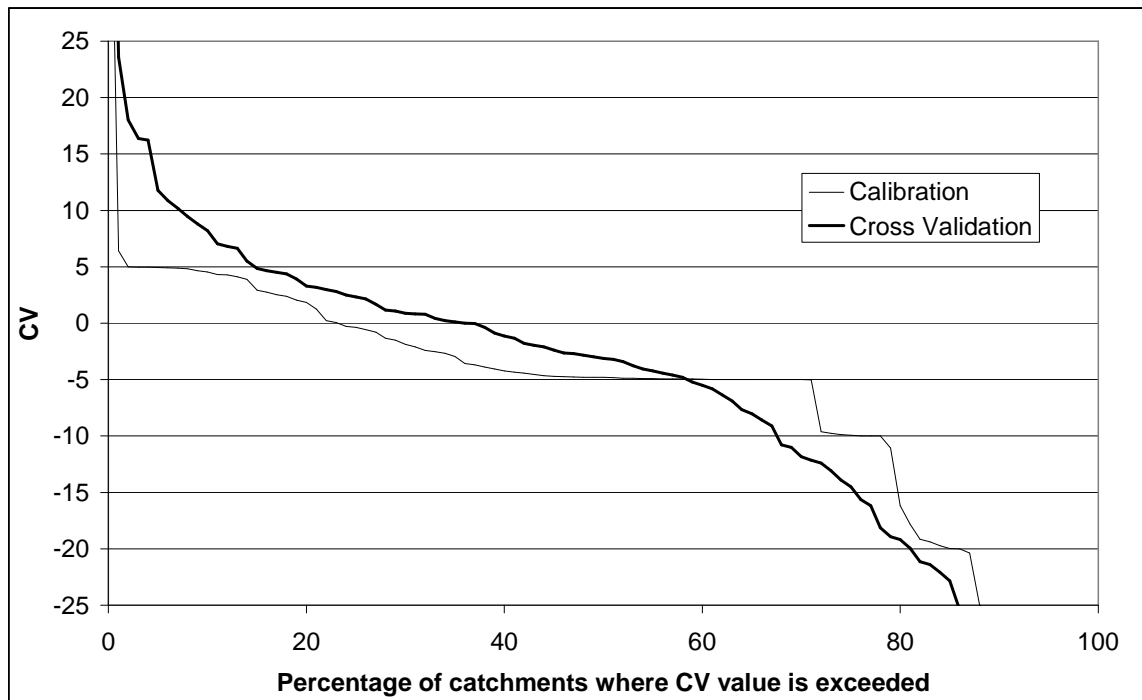

Figure 3.3. Percentage of stations with CV values greater than or equal to a given CV value.

Figure 3.3 is a plot of the percentage of catchments that have a CV value that exceeds a given CV value. The calibration results indicate that SIMHYD can generally reproduce the inter-annual variability in the observed streamflow. Some 66% of catchments have a CV value within 5% of the recorded value, 78% of catchments within 10% and 86% of catchments within 20%. The calibration penalty applied to the objective function when CV is not within 5% of the recorded CV value appears to have been less successful than the TVOL penalty noted above (Section 2.4). The cross validation results indicate that some 44% of catchments had a CV value within 5% of the recorded value, 60% within 10% and 80% within 20%. Considering that the average record length of the stations where CV was calculated is 32 years, these results would appear to be reasonable.

All values of E, TVOL and CV for both calibration and cross validation are presented by state and territory in Appendix 2.

Plots of estimated versus recorded streamflow for both the calibration and cross validation and a monthly time series plot for calibration, cross validation and recorded streamflow are presented in Appendix 3 for eight stations as a visual reference to what the objective measures of model performance indicate.

4. Extension of Streamflow

Suitable catchments for streamflow extension are determined using a selection criteria based on the objective measures of model performance described in Section 3.1. Three measures of model performance are included in the selection criteria; the quality of the calibration and cross validation as measured by the coefficient of efficiency and the cross validation percentage difference in total estimated and recorded streamflow. The stations are classified into four groups, “Good”, “Satisfactory”, “Passable” and “Poor”. Values of model performance measures for each classification are listed in Table 4.1.

Table 4.1. Model performance selection criteria

Classification	Calibration E	Cross Validation E	Cross Validation TVOL
Good	≥ 0.8	≥ 0.8	Within 5%
Satisfactory	≥ 0.6	≥ 0.6	Within 10%
Passable	≥ 0.6	≥ 0.3	Within 15%
Poor	< 0.6	< 0.3	Beyond 15%

Catchments are classified according to whether the model performance measures satisfy all the respective criteria for a given classification. Catchments classified as “Poor” are not used for streamflow extension. The model performance classification for each catchment is presented by state and territory in Appendix 2.

A summary of the number of catchments in each model performance classification by state and territory is presented in Table 4.2

Table 4.2. Number of catchments by model performance classification and state or territory

Classification	Good	Satisfactory	Passable	Poor
ACT	0	3	0	3
NSW	51	66	38	33
NT	0	5	0	0
QLD	11	7	0	2
SA	2	4	2	3
TAS	9	2	4	1
VIC	35	30	8	2
WA	3	6	0	1
Total	111	123	52	45

The difference in annual estimated and recorded coefficient of variation is not included in the model performance selection criteria, due to the small sample sizes used to calculate CV relative to those used to calculate E and TVOL.

5. Relationship between model parameters and catchment characteristics

The rainfall-runoff model SIMHYD conceptually simulates the hydrological processes, therefore it is possible that the model parameters may be related to catchment characteristics, like climate, topography, soil, vegetation, catchment shape, geology, drainage network and other characteristics.

Visual inspection of maps of the 331 optimised parameters (Chiew et al, 2000) failed to clearly identify regional groupings of parameter values. To objectively investigate the relationship between model parameters and catchment characteristics, correlations between the model parameters and four indices that reflect climate, terrain and soil characteristics are investigated here.

The climate is likely to affect the relative importance of different processes occurring within a catchment, particularly the degree to which seasonal drying may occur, which is likely to influence the soil moisture storage. The ratio of the mean annual rainfall to the mean annual areal potential evapotranspiration is used here to reflect the climate characteristic.

Processes such as lateral flow, saturation excess runoff and groundwater flow are influenced by relief. The difference between the 90th percentile and the 10th percentile elevation in a catchment is used here as an index of typical relief in a catchment. The AUSLIG 9 second Digital Elevation Model of Australia is used to estimate this relief index.

Soil characteristics also affect a range of hydrological processes including infiltration, soil moisture storage, lateral flow and groundwater recharge. It would therefore be expected that the model parameters might be related to soil properties. The soil depth and plant available water holding capacity are used here because they should reflect the soil moisture storage behaviour of the catchments. A range of other soil parameters could also have been chosen and will be considered in a more detailed analysis in the future. The soil properties are estimated for each catchment from the estimations of soil properties by McKenzie et al. (2000) for soil types classified using the Northcote (1979) classification scheme and the Atlas of Australian Soils (Northcote et al., 1960-1968). The Atlas of Australian Soils is a reconnaissance level mapping of soil-landscape types and each soil-landscape category may encompass several soil types. The parameters are estimated for each catchment by

assuming each soil-landscape unit can be represented by the dominant soil type (as identified by McKenzie et al., 2000) and that the most common of these dominant soil types can then represent the catchment. The parameters of this soil provided by McKenzie et al. are then used. Although there are many inaccuracies in determining the soil properties, the data used here are the most detailed source of soils data available at present for Australia.

Table 5.1 presents the correlations (coefficients of determination) of the linear regression between the optimised parameter values and the four catchment characteristics. The correlations are presented for the analyses of parameter values for all 331 catchments, as well as analyses of parameter values for three different climate regions. The three climate regions are chosen to roughly coincide with the Köppen climate classification system (Petterssen, 1958). The Cwa region is defined in the Köppen classification as temperate with dry winter and hot summer. The Csa region is temperate with dry and hot summer. The Cfa/Cfb region is defined as temperate with no dry season and a warm to hot summer, although the rainfall in the catchments in the Cfa/Cfb region here varies from being uniform throughout the year to being dominated by winter rainfall. Geographically, the Cfa/Cfb region consists of all the Victorian catchments, the Cwa region consists of coastal catchments in New South Wales and Queensland, and the Csa region consists of catchments in the Murray-Darling Basin in New South Wales.

There are 123 catchments in the Cwa region, 91 catchments in the Csa region and 75 catchments in the Cfa/Cfb region. The correlations are only presented in Table 5.1 if they are statistically significant at $\alpha = 0.05$ (with 100 data points, $R^2 > 0.04$ is statistically significant at $\alpha = 0.05$). Coefficient of determination values of 0.10 and above are highlighted in bold and values of 0.20 and above are highlighted in underlined bolds.

Table 5.1. Coefficient of determination (R^2) of the linear regression between optimised parameter values and catchment characteristics.

Correlation against climate index (mean annual rainfall divided by mean annual areal potential evapotranspiration)							
	INSC	COEFF	SQ	SMSC	SUB	CRAK	K
All data				0.05	0.13	<u>0.20</u>	
Cwa						0.09	
Csa	0.05	0.05	0.05	<u>0.20</u>	0.07	0.23	0.06
Cf	0.05		<u>0.24</u>	<u>0.25</u>	0.12	0.17	0.18
Correlation against relief index (90 th percentile minus 10 th percentile elevation in catchment)							
	INSC	COEFF	SQ	SMSC	SUB	CRAK	K
All data						0.12	
Cwa						0.08	
Csa				0.11	0.05	0.05	
Cf			0.10	<u>0.21</u>		0.12	0.11
Correlation against soil depth							
	INSC	COEFF	SQ	SMSC	SUB	CRAK	K
All data						0.06	
Cwa						0.07	
Csa			0.13				
Cf				0.14	0.05		0.05
Correlation against plant water holding capacity							
	INSC	COEFF	SQ	SMSC	SUB	CRAK	K
All data						0.09	
Cwa						0.11	
Csa			0.07	0.05			
Cf			0.10	0.10	0.06	0.08	

The climate is likely to be the main factor distinguishing the 331 catchments. In the analyses of optimised parameter values for all the 331 catchments, statistically significant correlations against the climate index are identified for three of the seven model parameters (SMSC, SUB and CRAK) while statistically significant correlations are identified only for one parameter (CRAK) in the correlations against relief and the two soil characteristics. It is for this reason that the relationship between model

parameters and catchment characteristics are investigated separately for the three climate regions. As climate is the main driving factor, analyses within similar climate regions should lead to the identification of better relationships between model parameters and catchment characteristics.

Nevertheless, in the analyses for individual climate regions, the highest correlations are also obtained against the climate index. The correlations between the model parameters and the climate index are statistically significant for all seven parameters in the Csa region and six parameters in the Cfa/Cfb region, but only for one parameter in the Cwa region. In the relationship against the relief index, the correlations are significant for one, three and four parameters respectively in the Cwa, Csa and Cfa/Cfb regions. In the relationship against the soil depth, the correlations are significant for three parameters in the Cfa/Cfb region and but statistically significant for only one parameter in the Cwa and Csa regions. In the relationship against the plant available water holding capacity, the correlations are significant for four parameters in the Cfa/Cfb region but only for one and two parameters respectively in the Cwa and Csa regions.

The correlations are highest in CRAK (used in the estimation of groundwater recharge – see Figure 2.2), being statistically significant in almost all the results presented in Table 5.1. The next highest correlations are in SMSC, the soil moisture store capacity. There are also reasonable correlations in SQ (exponent in infiltration capacity equation) and SUB (used in the estimation of interflow), but little to no correlation between INSC (interception capacity), COEFF (maximum infiltration capacity), and K (baseflow linear recession parameter) and the catchment characteristics. It is also interesting to note that the highest parameter cross-correlations are between CRAK, SMSC and SQ (see Chiew et al., 2000).

In summary the simple exploration here suggests that there are high statistical significance between some of the model parameters and several catchment characteristics. The parameter cross-correlations are also very low indicating that there is little co-linearity between the different model parameters. This potential for relating the model parameters to catchment characteristics will be explored further via a more detailed multivariate statistical analysis. For example, the analysis will take into account the relative importance of the parameters in affecting the runoff estimates and considers the potential relationship with combinations of different types of catchment characteristics. It is possible that the detailed analysis can lead to a successful development of relationships between model parameters and catchment characteristics for use in ungauged catchments.

6. Acknowledgements

This project is funded by the National Land and Water Resources Audit as part of Project 1 in Theme 1 (Water Availability).

This project is also partly supported by the LWRRDC project on seasonal streamflow forecasting to improve the management of water resources.

The assistance of the following people in providing monthly streamflow data is greatly appreciated, Dr Ross James (Rainman project), Dr Rory Nathan (Sinclair Knights Merz – Victoria), Robert Phillips, David Fuller and Bryce Graham (DPIWE – Tasmania) and Robin Leaney (DEHAA – South Australia).

The gridded daily rainfall data are provided by Alan Beswick and Keith Moody from the Queensland Department of Natural Resources.

7. References

- Boughton W.C., ed. 1999, A century of water resources development in Australia, 1900-1999. The Institution of Engineers, Australia, 258 pp.
- Chiew F.H.S. & McMahon T.A. 1993, Assessing the adequacy of catchment streamflow yield estimates. *Aust. J. Soil Res.*, 31:665-680.

- Chiew, F.H.S. & McMahon, T.A. 1994, Application of the daily rainfall-runoff model MODHYDROLOG to twenty-eight Australian catchments. *Journal of Hydrology*, 153:383-416.
- Chiew, F.H.S., Stewardson, M.J. & McMahon, T.A. 1993, Comparison of six rainfall-runoff modelling approaches. *Journal of Hydrology*, 147:1-36.
- Chiew, F.H.S., Whetton, P.H., McMahon, T.A. & Pittock, A.B. 1995, Simulation of the impacts of climate change on runoff and soil moisture in Australian catchments. *Journal of Hydrology*, 167:121-147.
- Chiew, F.H.S., Pitman, A.J. & McMahon, T.A. 1996, Conceptual catchment scale rainfall-runoff models and AGCM land-surface parameterisation schemes. *Journal of Hydrology*, 179:137-157.
- Chiew F.H.S., Peel M.C. & Western A.W. 2000, Application and testing of the simple rainfall-runoff model SIMHYD. In preparation.
- DEHAA 2000, Unpublished Data. Department for Environment and Aboriginal Affairs, Environment Protection Agency, South Australia.
- DLWC, 1999, Pinneena: New South Wales Surface Water Data Archive (Version 6.1. – CD-ROM). Department of Land & Water Conservation. New South Wales.
- DPIWE 2000, Unpublished Data. Department of Primary Industries, Water and Environment, Tasmania.
- Efron B. & Tibshirani R.J. 1993, *An Introduction to the Bootstrap*. Chapman & Hall, New York, 436 pp.
- Hooke R. & Jeeves T.A. 1961, “Direct Search” solution of numerical and statistical problems. *J. Assoc. Comput. Mach.*, 8(2): 212-229.
- McKenzie, N.J., Jacquier, D.W., Ashton, L.J. & Cresswell, H.P. 2000, Estimation of Soil Properties Using the Atlas of Australian Soils, CSIRO Land and Water, Canberra, Australia, Technical Report 11/00.
- Monro, J.C. 1971, Direct search optimisation in mathematical modelling and a watershed model application. National Oceanic Atmospheric Administration, National Weather Service, U.S. Dept. of Commerce, NOAA, Silver Spring, MD, Tech. Memo. NWS HYDRO-12, 52 pp.
- Morton, F.I. 1983, Operational estimates of actual evapotranspiration and their significance to the science and practice of hydrology. *Journal of Hydrology*, 66:1-76.
- Nash J.E. & Sutcliffe J.V. 1970, River flow forecasting through conceptual models Part 1 - A discussion of principles. *Journal of Hydrology*, 10:282-290.
- Nathan R.J. & Weinmann P.E. 1993, Drought management plan for Victoria’s water resources: Low flow atlas for Victorian streams. Department of Conservation and Natural Resources Victoria.
- Northcote, K.H. 1979, *A Factual Key for the Recognition of Australian Soils*. Relim Technical Publications, Coffs Harbour, New South Wales, Australia, 123 pp.
- Northcote, K.H. et al. 1960-1968, *Atlas of Australian Soils, Sheets 1-10 with Explanatory Data*. CSIRO Australia and Melbourne University Press.
- Petterssen S. 1958, *Introduction to Meteorology: International student edition*, 2nd edition, McGraw-Hill, Tokyo, 327 pp.

- Porter, J.W. & McMahon, T.A. 1975, Application of a catchment model in south eastern Australia. *Journal of Hydrology*, 24:121-134.
- Porter, J.W. & McMahon, T.A. 1976, The Monash Model: User Manual for Daily Program HYDROLOG. Dept. of Civil Engineering, Monash University, Research Report 2/76, 41 pp.
- Wang, Q.J., McConachy, F.L.N., Chiew, F.H.S., James, R., deHoedt, G.C. & Wright, W.J. 2000, Climatic Atlas of Australia: Maps of Evapotranspiration. Australian Bureau of Meteorology, In Press.

Appendix 1

The following table lists all of the gauging stations modelled as part of this project by state or territory. The table headings are defined below.

- Gauge = Australia Water Resources Council gauging station number
- Station Name = The river name and gauging station name
- Lat. = Latitude in decimal degrees
- Long. = Longitude in decimal degrees
- Area = Catchment area in square kilometers (km²)
- Rain = Areal mean annual rainfall in millimeters (mm)
- Runoff = Recorded mean annual runoff in millimeters (mm)
- Coeff = Proportion of rainfall converted to runoff (Runoff/Rain).

Australian Capital Territory							
Gauge	Station Name	Lat.	Long.	Area	Rain	Runoff	Coeff
410705	Molonglo R at Burbong Bridge	35.34	149.31	505	721	91	0.13
410730	Cotter at Gingera	35.59	148.82	148	1139	318	0.28
410731	Gudgenby at Tennent	35.58	149.07	670	905	106	0.12
410733	Coree at Threeways	35.33	148.89	70	1006	213	0.21
410734	Queanbyan at Tinderry	35.62	149.35	490	884	141	0.16
410736	Orroral at Crossing	35.67	148.99	90	1017	132	0.13
New South Wales							
Gauge	Station Name	Lat.	Long.	Area	Rain	Runoff	Coeff
201001	Oxley River @Eungella	28.35	153.29	213	1882	656	0.35
201005	Rous River @Boat Harbour No.2	28.3	153.33	111	2119	887	0.42
201011	Doon Doon Creek @Lower Doon Doon	28.44	153.31	54	2289	1056	0.46
201900	Tweed River @Uki	28.41	153.33	275	1916	552	0.29
203002	Coopers Creek @Repentance	28.64	153.41	62	2104	964	0.46
203005	Richmond River @Wiangaree	28.5	152.97	702	1249	364	0.29
203010	Leycester River @Rock Valley	28.74	153.17	179	1421	504	0.35
203030	Myrtle Creek @Rappville	29.1	153	332	1159	190	0.16
204016	Little Murray River @North Dorrigo	30.27	152.66	104	1703	1041	0.61
204017	Bielsdown Creek @Dorrigo No.2 & No.3	30.3	152.72	82	1884	1202	0.64
204019	Nymboida River @Bostobrick	30.26	152.6	220	1521	629	0.41
204025	Orara River @Karangi	30.27	153.03	135	1793	755	0.42
204026	Bobo River @Bobo Nursery	30.26	152.85	80	2116	1219	0.58
204030	Aberfoyle River @Aberfoyle	30.27	152.01	200	869	92	0.11
204031	Mann River @Shannon Vale	29.73	151.85	348	901	83	0.09
204033	Timbarra River @Billyrimba	29.19	152.25	985	990	158	0.16
204034	Henry River @Newton Boyd	29.75	152.22	389	939	118	0.13
204036	Cataract Creek @Sandy Hill(Below Snake Creek)	28.94	152.22	236	993	237	0.24
204037	Clouds Creek @Clouds Creek	30.1	152.63	62	1298	267	0.21
204041	Orara River @Bawden Bridge	29.73	152.81	1790	1331	441	0.33
204055	Sportsmans Creek @ Gurranang Siding	29.47	152.98	202	1157	259	0.22
204056	Dandahra Creek @Gibraltar Range	29.49	152.45	104	1149	624	0.54
204067	Gordon Brook @Fine Flower	29.41	152.65	315	1154	267	0.23
205002	Bellinger River @Thora	30.43	152.78	433	1485	550	0.37
205006	Nambucca River @Bowraville	30.64	152.86	539	1558	371	0.24
205008	Taylors Arm @Grays Crossing	30.75	152.77	319	1506	478	0.32
205012	Corindi Creek @ Upper Corindi	30.04	153.12	55	1583	489	0.31
205014	Never Never River @Gleniffer Bridge	30.39	152.88	51	2036	1114	0.55
206009	Tia River @Tia	31.19	151.83	261	978	209	0.21
206014	Wollomombi River @Coninside	30.47	152.03	376	820	99	0.12
206018	Apsley River @Apsley Falls	31.06	151.77	894	807	65	0.08

206020	Styx River @Serpentine (Hyatts Flat)	30.52	152.3	78	1435	930	0.65
206025	Salisbury Waters Near Dangar Falls	30.67	151.71	594	789	56	0.07
206034	Mihi Creek @Abermala	30.69	151.71	117	787	54	0.07
207006	Forbes River @Birdwood(Filly Flat)	31.37	152.33	363	1304	516	0.40
207012	Doyles River @Doyles River Road	31.5	152.22	65	1354	337	0.25
207013	Ellenborough River D/S Bunnoo River Junction	31.47	152.44	515	1423	337	0.24
207014	Wilson River @Avenel	31.32	152.74	505	1303	424	0.33
207015	Hastings River @Mount Seaview	31.37	152.24	342	1138	337	0.30
208002	Manning River At Tomalla (Campbells No.2)	31.85	151.54	52	1385	749	0.54
208005	Nowendoc River @Rocks Crossing	31.77	152.08	1870	1057	203	0.19
208006	Barrington River @Forbesdale (Causeway)	31.03	151.87	630	1196	501	0.42
208007	Nowendoc River @Nowendoc	31.52	151.72	218	1027	261	0.25
208008	Gloucester River @Forbesdale(Faulklands)	32.06	151.89	207	1183	398	0.34
208009	Barnard River @Barry	31.58	151.31	150	1068	247	0.23
208012	Manning River @Woko	31.84	151.89	480	1114	263	0.24
208015	Landsdowne River @Landsdowne	31.79	152.51	96	1540	481	0.31
208019	Dingo Creek @Munyaree Flat	31.84	152.29	492	1408	541	0.38
208022	Barnard River @The Pimple	31.64	151.56	745	905	132	0.15
208026	Myall River @Jacky Barkers	31.64	151.74	560	1065	203	0.19
209001	Karuah R At Monkerai	32.24	151.85	203	1403	710	0.51
209002	Mammy Johnsons River @ Crossing	32.25	151.98	156	1133	302	0.27
209006	Wang Wauk River @Willina	32.15	152.26	150	1007	208	0.21
210014	Rouchel Brook At Rouchel Brook (The Vale)	32.15	151.05	395	864	120	0.14
210017	Moonan Brook At Moonan Brook	31.94	151.28	103	1132	244	0.22
210022	Allyn River @Halton	32.3	151.53	205	1171	409	0.35
210040	Wybong Creek At Wybong	32.27	150.64	676	685	32	0.05
210042	Foy Brook At Ravensworth	32.39	151.05	170	771	95	0.12
210048	Wollombi Brook @Paynes Crossing	32.87	151.07	1064	899	102	0.11
210061	Pages River @Blandford (Bickham)	31.8	150.93	302	897	135	0.15
210080	West Brook @U/S Glendon Brook	32.47	151.28	80	847	115	0.14
210081	Pages Creek At U/S Hunter River	31.75	151.24	104	951	129	0.14
210082	Wollar Creek @U/S Goulburn River	32.33	149.95	274	677	14	0.02
210088	Dart Brook @Aberdeen No.2	32.17	150.87	799	698	44	0.06
210091	Merriwa River At Merriwa	32.14	150.35	465	707	37	0.05
210092	Krui River At Collaroy	32.12	150.1	498	689	49	0.07
211008	Jigadee Creek @Avondale	33.07	151.47	55	1125	365	0.32
211013	Ourimbah Creek @U/S Weir	33.34	151.34	83	1230	331	0.27
211014	Wyong River @Yarramalong	33.22	151.27	181	1078	223	0.21
212018	Capertee River At Glen Davis	33.12	150.28	1010	712	38	0.05
212021	Macdonald River @Howes Valley	32.85	150.81	299	814	81	0.10
212028	Wolgan River At Newnes	33.18	150.23	238	853	131	0.15
212040	Kialla Creek At Pomeroy	34.6	149.54	96	757	86	0.11
212045	Coxs River At Island Hill	33.77	150.2	970	876	116	0.13
215002	Shoalhaven River At Warri	35.35	149.73	1450	856	219	0.26
215004	Corang River At Hockeys	35.15	150.03	166	785	344	0.44
215005	Mongarlowe River At Marlowe	35.27	149.91	417	831	434	0.52
215008	Shoalhaven River At Kadoona	35.79	149.64	280	965	337	0.35
216004	Currambene Creek At Falls Creek	34.97	150.6	95	1199	291	0.24
216009	Buckenbowra River At Buckenbowra No.3	35.71	150.03	168	943	261	0.28
218001	Tuross River At Tuross Vale	36.27	149.51	93	946	368	0.39
218002	Tuross River At Belowra	36.21	149.71	556	909	271	0.30
218006	Wandella Creek At Wandella	36.33	149.82	57	1013	349	0.34
218007	Wadbilliga River At Wadbilliga	36.27	149.69	122	915	317	0.35
219013	Brogo River At North Brogo	36.54	149.83	460	906	291	0.32
219016	Narira River At Cobargo	36.39	149.94	92	983	206	0.21
219017	Double Creek Near Brogo	36.6	149.81	152	938	253	0.27

220002	Stockyard Creek At Rocky Hall (Whitbys)	35.94	149.5	75	1094	216	0.20
220003	Pambula River At Lochiel	36.94	149.82	105	903	237	0.26
220004	Towamba River At Towamba	37.08	149.66	745	949	204	0.21
221002	Wallagaraugh River At Princes Highway	37.37	149.71	479	957	224	0.23
221003	Genoa River At Bondi	37.17	149.32	235	958	219	0.23
221010	Imlay Creek At Imlay Road Bridge	37.23	149.7	70	983	246	0.25
222001	Maclaughlin River At Dalgety Road	36.64	149.11	292	712	159	0.22
222004	Little Plains River At Wellesley (Rowes)	36.99	149.09	604	893	144	0.16
222007	Wullwye Creek At Woolway	36.43	148.91	520	587	44	0.08
222009	Bombala River At The Falls	36.93	149.21	559	858	202	0.23
222010	Bobundara Creek At Dalgety Road	36.5	148.94	360	583	47	0.08
222011	Cambalong Creek At Gunning Grach	36.76	149.17	188	654	98	0.15
222014	Delegate River At Delegate	37.04	148.93	313	929	186	0.20
222015	Jacobs River At Jacobs Ladder	36.75	148.43	187	1000	219	0.22
222016	Pinch River At The Barry Way	36.79	148.4	155	1084	300	0.28
222017	Maclaughlin River At The Hut	36.65	149.11	313	618	69	0.11
401008	Mannus Creek @ Tooma	35.94	148.03	504	1002	187	0.19
401009	Maragle Creek @ Maragle	35.93	148.1	220	1062	177	0.17
401012	Murray River @ Biggara	36.32	148.05	1165	1331	421	0.32
401013	Jingellic Creek @ Jingellic	35.89	147.69	378	929	164	0.18
401015	Bowna Creek @ Yambla	35.93	146.98	316	702	39	0.06
401016	Welumba Creek @ The Square	36.04	148.12	52	1038	191	0.18
410033	Murrumbidgee River @ Mittagang Crossing	36.17	149.09	1891	882	134	0.15
410038	Adjungbilly Creek @ Darbalara	35.02	148.25	411	1180	211	0.18
410044	Muttama Creek @ Coolac	34.93	148.16	1025	628	53	0.08
410047	Tarcutta Creek @ Old Borambola	35.15	147.66	1660	818	110	0.13
410048	Kyeamba Creek @ Ladysmith	35.19	147.51	530	610	74	0.12
410057	Goobarragandra River @ Lacmalac	35.32	148.35	673	1319	429	0.33
410059	Gilmore Creek @ Gilmore	35.33	148.17	233	1216	386	0.32
410061	Adelong Creek @ Batlow Road	35.33	148.07	155	1138	256	0.22
410067	Big Badja River @ Numeralla (Goodwins)	36.15	149.4	220	933	314	0.34
410071	Brungle Creek @ Red Hill	35.14	148.25	114	975	168	0.17
410077	Bredbo River @ Laguna	35.99	149.4	75	925	179	0.19
410096	Mountain Creek @ Thomond North	35.79	147.16	160	760	101	0.13
410097	Billabong Creek @ Aberfeldy	35.64	147.44	331	705	75	0.11
410105	Numeralla River @ Numeralla Dam Site	36.32	149.29	321	712	154	0.22
410111	Yaven Yaven Creek @ Spyglass	35.41	147.93	77	988	344	0.35
410126	Demonrille Creek @ Wongabara	34.54	148.3	171	642	27	0.04
410141	Micaligo Creek @ Michelago	35.71	149.15	190	763	54	0.07
411003	Butmaroo Creek At Butmaroo	35.27	149.54	65	713	108	0.15
412063	Lachlan River @ Gunning	34.75	149.29	570	737	76	0.10
412066	Abercrombie River @ Hadley No.2	34.1	149.6	1630	814	123	0.15
412068	Goonigal Creek @Gooloogong	33.6	148.38	363	599	28	0.05
412071	Canomodine Creek @Canomodine	33.5	148.79	132	771	40	0.05
412072	Back Creek @Koorawatha	34.02	148.54	840	595	27	0.05
412073	Nyrang Creek @Nyrang	33.54	148.55	225	618	12	0.02
412076	Bourimbla Creek @Cudal	33.32	148.71	124	779	134	0.17
412080	Flyers Creek @Beneree	33.5	149.04	98	915	106	0.12
412082	Phils Creek @Fullerton	34.23	149.55	106	821	124	0.15
412089	Cooks Vale Creek @ Peelwood	34.08	149.46	142	780	86	0.11
412092	Coombing Creek @Near Neville	33.65	149.21	132	918	172	0.19
412096	Pudmans Creek @ Kennys Creek Road	34.44	148.79	332	697	85	0.12
412110	Bolong River @ U/S Giddigang Creek	34.3	149.63	171	794	102	0.13
416008	Beardy River @Haystack	29.24	151.38	866	799	85	0.11
416020	Ottleys Creek @Coolatai	29.25	150.76	402	731	37	0.05
416021	Frazers Creek @Ashford	29.35	151.1	804	805	86	0.11

416022	Severn River @Fladbury	29.52	151.7	1100	843	76	0.09
416023	Deepwater River @Bolivia	29.3	151.93	505	874	82	0.09
416035	Macintyre River @Elsmore	29.82	151.28	521	886	106	0.12
416036	Campbells Creek @Near Beebo	28.72	150.88	399	648	20	0.03
418005	Copes Creek @Kimberley	29.92	151.12	259	850	89	0.11
418015	Horton River @Rider (Killara)	29.83	150.35	1970	819	108	0.13
418016	Warialda Creek @Warialda No.2	29.55	150.53	544	692	31	0.05
418017	Myall Creek @Molroy	29.8	150.58	842	742	48	0.07
418020	Boorolong Creek @Yarrowyck	30.47	151.43	311	829	122	0.15
418021	Laura Creek @Laura	30.23	151.19	311	848	119	0.14
418024	Roumalla Creek @Kingstown	30.47	151.15	487	779	78	0.10
418025	Halls Creek @Bingara	29.91	150.58	156	755	44	0.06
418027	Horton River @Horton Dam Site	30.21	150.43	220	946	199	0.21
418032	Tycannah Creek @Horseshoe Lagoon	29.67	150.05	866	693	31	0.05
418033	Bakers Creek @Bundarra	30.21	151.03	173	758	51	0.07
419010	Macdonald River @Woolbrook	30.97	152.35	829	903	137	0.15
419029	Halls Creek @Ukolan	30.71	150.82	389	762	46	0.06
419035	Goonoo Goonoo Creek @Timbumburi	31.27	150.92	503	811	55	0.07
419044	Maules Creek At Damsite	30.52	150.3	171	842	40	0.05
419047	Ironbark Creek At Woodsreef	30.42	150.73	581	778	56	0.07
419050	Connors Creek At Barraba	30.35	150.64	73	700	35	0.05
419053	Manilla River At Black Springs	30.43	150.65	791	755	53	0.07
419054	Swamp Oak Creek @Limbri	31.04	151.17	391	847	79	0.09
419055	Mulla Creek @Goldcliff	31.1	151.15	254	905	140	0.15
419072	Baradine Creek @Kienbri No.2	30.85	149.03	1000	752	16	0.02
419076	Warrah Creek @Old Warrah	31.65	150.64	150	845	80	0.10
420003	Belar Creek @Warkton (Blackburns)	31.39	149.2	133	887	78	0.09
420010	Wallumburrawang Creek @Bearbung	31.67	148.87	452	701	20	0.03
421018	Bell River @Newrea	32.67	148.95	1620	729	73	0.10
421026	Turon River At Sofala	33.1	149.69	883	840	133	0.16
421036	Duckmaloi River @Below Dam Site	33.77	149.94	112	967	244	0.25
421048	Little River @Obley No.2	32.71	148.55	612	687	71	0.10
421050	Bell River @Molong	33.02	148.95	365	826	94	0.11
421055	Coolbaggie Creek @Rawsonville	32.14	148.45	626	591	28	0.05
421056	Coolaburragundy River @Coolah	31.82	149.74	216	740	46	0.06
421066	Green Valley Creek At Hill End	32.95	149.47	119	772	119	0.15
421068	Spicers Creek @Saxa Crossing	32.2	149.02	377	661	9	0.01
421076	Bogan River @Peak Hill No.2	32.73	148.13	1036	543	23	0.04
421084	Burrill Creek @Mickibri	32.89	148.22	163	597	25	0.04
421100	Pyramul Creek @U/S Hill End Road	32.93	149.47	193	778	136	0.18
421101	Campbells River At U/S Ben Chifley Dam	33.6	149.7	950	802	70	0.09
421104	Brisbane Valley Creek At Stromlo	33.69	149.73	98	831	89	0.11
421106	Cheshire Creek At Wiagdon	33.25	149.66	102	769	106	0.14
421125	Jones Creek @Tara	32.15	148.78	91	627	15	0.02
421126	Cainbil Creek @Loch Lomond	32.08	149.66	81	693	15	0.02
Northern Territory							
Gauge	Station Name	Lat.	Long.	Area	Rain	Runoff	Coeff
60046	Todd R at Wigley Gorge	23.63	133.88	360	297	32	0.11
8140008	Fergusson R at Old Railway Bridge	14.07	131.97	1490	1187	254	0.21
8140159	Seventeen Mile Ck at Waterfall View	14.23	132.4	619	1106	171	0.16
8200045	South Aligator R at El Sharana	13.53	132.53	1300	1305	364	0.28
8210007	Magela Ck at upstream Bowerbird Waterhole	12.78	133.05	260	1357	409	0.30
Queensland							
Gauge	Station Name	Lat.	Long.	Area	Rain	Runoff	Coeff
110003	Barron R at Picnic Crossing	17.27	145.53	220	1497	628	0.42
111007	Mulgrave R at Peets Bridge	17.13	145.77	545	2886	1383	0.48

112003	North Johnstone R at Glen Allen	17.37	145.65	173	1969	967	0.49
117002	Black R at Bruce Highway	19.23	146.63	260	1195	311	0.26
119003	Haughton R at Powerline	19.63	147.12	1735	898	220	0.25
120216	Broken R at Old Racecourse	21.2	148.45	78	1729	605	0.35
121002	Elliott R at Guthalungra	19.93	147.83	270	937	216	0.23
122003	Proserpine R at Peter Faust Dam	20.37	148.38	270	1185	295	0.25
125002	Pioneer R at Sarich's	21.3	148.83	740	1346	410	0.30
129001	Waterpark Ck at Byfield	22.83	150.67	245	1509	629	0.42
130319	Bell Ck at Craiglands	24.15	150.53	300	697	42	0.06
132001	Calliope R at Castlehope	23.98	151.08	1310	849	123	0.15
135002	Kolan R at Springfield	24.75	151.58	545	946	126	0.13
136202	Barambah Ck at Litzows	26.3	152.05	640	898	84	0.09
136315	Boyne R at Carters	26.25	151.3	1715	700	20	0.03
142001	Caboolture R at Upper Caboolture	27.1	152.88	98	1483	418	0.28
143110	Bremer R at Adams Bridge	27.83	152.52	130	960	163	0.17
145011	Teviot Brook at Croftby	28.15	152.57	82	1075	210	0.20
145018	Burnett Ck at U/S Maroon Dam	28.22	152.62	81	1411	218	0.15
145102	Albert R at Bromfleet	27.92	153.1	545	1325	252	0.19
South Australia							
Gauge	Station Name	Lat.	Long.	Area	Rain	Runoff	Coeff
239519	Mosquito Creek @Struan	37.1	140.77	1130	607	26	0.04
426504	Finniss River @ 4km East Of Yundi	35.33	138.67	191	849	147	0.17
502502	Myponga River @ U/S Dam And Road Bridge	35.38	138.48	76.5	820	115	0.14
505504	North Para River @ Turretfield	34.57	138.77	708	546	28	0.05
505517	North Para River @ Penrice	34.47	139.07	118	533	53	0.10
505532	Light River @ Mingays Waterhole	34.35	138.97	828	487	14	0.03
506500	WAKEFIELD RIVER @ Near Rhynie	34.1	138.63	417	551	25	0.05
507500	Hill River @ Andrews	33.62	138.63	235	553	24	0.04
507501	HUTT RIVER @ Near Spalding	33.55	138.6	280	569	28	0.05
509503	KANYAKA CREEK @ Sth Of Hawker	32.1	138.28	180	323	3	0.01
513501	Rocky River @ Flinders Chase(Ki)	35.63	136.7	190	757	83	0.11
Tasmania							
Gauge	Station Name	Lat.	Long.	Area	Rain	Runoff	Coeff
3080003	Franklin R at Mt Fincham	42.24	145.75	757	2445	2095	0.86
3120001	Hellyer R at Guilford	41.42	145.68	102	2062	1337	0.65
3180010	North Esk R at Ballroom	41.5	147.38	373	1173	447	0.38
3190200	Brid R u/s of tidal limit	41.03	147.37	139	1052	318	0.30
318900	Break O'day R. @ Killymoon Br.	41.6	148.06	187.0	942	271	0.29
303203	Coal R. @ Baden	42.43	147.45	53.2	625	139	0.22
307201	Davey R. D/S Crossing R.	43.14	145.95	686.0	2322	2068	0.89
319201	Great Forester R. 2km	41.11	147.61	193.0	1141	425	0.37
304201	Jordan R. @ Mauriceton	42.53	147.12	742.0	546	30	0.05
314207	Leven R. D/S Bannons Bridge	41.25	146.09	500.0	1775	1014	0.57
318852	Meander R. @ Strathbridge	41.49	146.91	1012.0	1085	469	0.43
302208	Meredith R. @ Swansea	42.12	148.04	86.4	586	213	0.36
319204	Pipers R. D/S Yarrow Ck.	41.07	147.11	298.0	956	317	0.33
318311	St Pauls R. U/S South Esk R.	41.79	147.73	495.0	687	161	0.24
302200	Swan R. @ The Grange	42.05	148.07	448.0	763	281	0.37
304206	Tyenna @ Newbury	42.71	146.71	205.0	1305	831	0.64
Victoria							
Gauge	Station Name	Lat.	Long.	Area	Rain	Runoff	Coeff
221201	Cann R (West Branch) at Weeragua	37.375	149.2	311	1016	196	0.19
221204	Thurra R at Point Hicks	37.723	149.258	345	1027	257	0.25
221210	Genoa R at The Gorge	37.417	149.517	837	966	189	0.20
222202	Brodrigg R at Sardine Ck	37.51	148.542	650	1044	201	0.19

222206	Buchan R at Buchan	37.5	148.175	850	1025	191	0.19
222213	Suggan Buggan R at Suggan Buggan	36.95	148.492	357	1093	156	0.14
223202	Tambo R at Swifts Ck	37.267	147.725	943	819	87	0.11
223207	Timbarra R at Timbarra	37.317	148.042	205	985	287	0.29
224201	Wonnangatta R at Waterford	37.483	147.167	1979	1281	289	0.23
224207	Wongungarra R at Guys	37.383	147.1	736	1460	287	0.20
224209	Cobbannah Ck near Bairnsdale	37.828	147.35	106	752	118	0.16
225213	Aberfeldy R at Beardmore	38.15	146.432	311	1236	242	0.20
225217	Barkly R at Glencairn	37.558	146.567	248	1288	412	0.32
225218	Freestone Ck at Briagolong	37.812	147.093	311	797	129	0.16
225219	Macalister R at Glancairn	37.517	146.567	570	1330	432	0.32
226007	Tyers R at Browns	38.05	146.355	207	1380	449	0.33
226204	La Trobe R at Willow Grove	38.092	146.158	580	1350	375	0.28
226218	Narracan Ck at Thorpdale	38.275	146.183	66	1042	356	0.34
226405	Middle Ck at Yinnar South	38.377	146.362	69.2	1225	275	0.22
226406	Little Morwell R at Boolarra	38.408	146.307	114	1023	97	0.10
226410	Traralgon Ck at Koornalla	38.49	146.528	89	1443	302	0.21
227200	Tarra R at Yarram	38.543	146.68	218	1060	190	0.18
227202	Tarwin R at Meeniyan	38.583	145.992	1067	1054	252	0.24
227211	Agnes R at Toora	38.643	146.372	67	1301	391	0.30
227219	Bass R at Loch	38.375	145.558	52	1140	347	0.30
228203	Eumemmering Ck at Lyndhurst	38.025	145.233	149	834	159	0.19
228206	Tarago R at Neerim	37.967	145.933	80.1	1403	281	0.20
228212	Bunyip R at Tonimbuk	38.025	145.758	174	1319	180	0.14
229215	Woori Yallock Ck at Woori Yallock	37.767	145.517	311	1169	313	0.27
230205	Maribyrnong R at Bulla (DS of Emu Ck Junction)	37.633	144.8	865	730	82	0.11
231213	Lerderderg R at Sardine Ck (O'Briens X-ing)	37.5	144.367	153	1083	207	0.19
233215	Leigh at Mount Mercer	37.817	143.917	593	738	98	0.13
233223	Warrambine Ck at Warrambine	37.933	143.867	57.2	688	41	0.06
234200	Woody Yallock at Pitfield	37.808	143.583	324	709	55	0.08
234203	Pirron Yallock Ck at Pirron Yallock (above HW Br)	38.35	143.425	166	841	111	0.13
235203	Curdies R at Curdie	38.45	142.967	790	912	143	0.16
235211	Kennedys Ck at Kennedys Creek	38.583	143.25	268	978	155	0.16
236203	Mount Emu Ck at Skipton	37.692	143.358	1251	693	47	0.07
236205	Merri R at Woodford	38.317	142.483	899	746	78	0.10
236212	Brucknell Ck at Cudjee	38.35	142.65	223	886	143	0.16
237200	Moyne R at Toolong	38.317	142.225	570	761	96	0.13
237205	Darlot Ck at Homerton Bridge	38.15	141.775	760	707	88	0.12
237206	Eumeralla R at Codrington	38.267	141.95	502	753	69	0.09
238223	Wando R at Wando Vale	37.5	141.425	174	705	101	0.14
401203	Mitta Mitta R at Hinnomunjie	36.942	147.608	1533	1332	299	0.22
401210	Snowy Ck at below Granite Flat	36.567	147.417	407	1374	493	0.36
401212	Nariel Ck at Upper Nariel	36.45	147.833	252	1483	551	0.37
402200	Kiewa R at Kiewa (Combined Flow)	36.41	147.02	1145	1428	542	0.38
402204	Yackandandah Ck at Osbornes Flat	36.307	146.903	255	1066	237	0.22
402206	Running Ck at Running Creek	36.54	147.045	126	1496	311	0.21
402406	Kiewa R (West Branch) at Snake Valley	36.822	147.16	88.1	2095	1363	0.65
403205	Ovens R at Bright	36.723	146.95	495	1587	474	0.30
403206	Buckland R at Buckland	36.8	146.85	303	1535	494	0.32
403213	Fifteen Mile Ck at Greta South	36.625	146.243	229	1171	291	0.25
403214	Happy Valley Ck at Rosewhite	36.583	146.82	135	1285	207	0.16
403217	Rose R at Matong North	36.993	146.583	154	1326	473	0.36
403224	Hurdle Ck at Bobinawarra	36.517	146.45	155	1091	211	0.19
403226	Boggy Ck at Angleside	36.608	146.367	108	1182	324	0.27
404208	Moonee Ck at Lima	36.763	145.97	90.9	1076	234	0.22
405205	Murrindindi R at Murrindindi above "Colwells"	37.403	145.558	108	1620	540	0.33

405209	Acheron R at Taggerty	37.32	145.717	619	1578	525	0.33
405214	Delatite R at Tonga Bridge	37.152	146.125	368	1239	348	0.28
405219	Goulburn R at Dohertys	37.333	146.13	694	1399	530	0.38
405226	Pranjip Ck at Moorilim	36.617	145.3	787	655	85	0.13
405228	Hughes Ck at Tarcombe Road	36.955	145.297	471	815	189	0.23
405229	Wanalta Ck at Wanalta	36.637	144.868	108	557	42	0.07
405237	Seven Creeks at Euroa, township	36.762	145.583	332	959	241	0.25
406213	Campaspe R at Redesdale	37.017	144.542	629	800	144	0.18
406214	Axe Ck at Longlea	36.775	144.427	234	608	72	0.12
407220	Bet Bet Ck at Norwood	36.997	143.64	347	607	66	0.11
407221	Jim Crow Ck at Yandoit	37.208	144.1	166	854	169	0.20
407236	Mount Hope Ck at Mitiamo	36.165	144.287	1629	479	22	0.05
407253	Piccaninny Ck at Minto	36.453	144.467	668	520	48	0.09
408202	Avoca R at Amphitheatre	37.183	143.408	78	658	78	0.12
415207	Wimmera R at Eversley	37.187	143.183	298	634	73	0.12
Western Australia							
<i>Gauge</i>	<i>Station Name</i>	<i>Lat.</i>	<i>Long.</i>	<i>Area</i>	<i>Rain</i>	<i>Runoff</i>	<i>Coeff</i>
601001	Young R at Neds Corner	33.71	121.14	1610	390	3	0.01
603004	Hay R at Sunny Glen	34.91	117.48	1161	713	54	0.08
603136	Denmark R at Mt Lindesay	34.87	117.31	525	807	59	0.07
604001	Kent R at Rocky Glen	34.62	117.03	1108	577	27	0.05
606001	Deep R at Teds Pool	34.77	116.62	457	916	82	0.09
608151	Donnelly R at Strickland	34.33	115.78	807	1013	164	0.16
610001	Margaret R at Willmots Farm	33.94	115.05	442	1000	216	0.22
611111	Thomson Brook at Woodperry Homestead	33.63	115.95	102	862	125	0.14
613002	Harvey R at Dingo Rd	33.09	116.04	148	1052	240	0.23
614196	Williams R at Saddleback Rd Br	33	116.43	1437	531	48	0.09

Appendix 2

The following table lists the model performance statistics and model performance classification for each station by state or territory. The table headings are defined below.

- Gauge = Australia Water Resources Council gauging station number
- Cal. E = Calibration E
- Cal. TVOL. = Calibration TVOL as a %
- Cal. CV = Calibration CV as a %
- Val. E = Validation E
- Val. TVOL. = Validation TVOL as a %
- Val. CV = Validation CV as a %
- Class = Model performance classification

Australian Capital Territory							
<i>Gauge</i>	<i>Cal. E</i>	<i>Cal. TVOL</i>	<i>Cal. CV</i>	<i>Val. E</i>	<i>Val. TVOL</i>	<i>Val. CV</i>	<i>Class</i>
410705	0.793	-4.353	-19.343	0.761	-3.682	-19.002	Satisfactory
410730	0.769	-3.663	-4.952	0.703	-3.635	-0.409	Satisfactory
410731	0.567	-4.936	-5.001	0.490	-4.369	-4.661	Poor
410733	0.768	-2.826	-4.999	0.720	-2.240	-4.705	Satisfactory
410734	0.522	-4.802	-4.911	0.588	-5.455	-8.648	Poor
410736	0.590	-0.537		0.337	3.186		Poor
New South Wales							
<i>Gauge</i>	<i>Cal. E</i>	<i>Cal. TVOL</i>	<i>Cal. CV</i>	<i>Val. E</i>	<i>Val. TVOL</i>	<i>Val. CV</i>	<i>Class</i>
201001	0.947	1.905	-1.612	0.938	3.214	6.049	Good
201005	0.891	-4.752	-9.985	0.866	-4.283	-8.385	Good
201011	0.940	2.973		0.916	4.133		Good
201900	0.904	4.968	9.486	0.825	2.376	21.064	Good
203002	0.958	-4.758	-0.387	0.952	-4.720	1.208	Good
203005	0.851	-2.521	-9.985	0.796	-3.901	-13.874	Satisfactory
203010	0.927	-18.861	-4.981	0.916	-12.664	-12.733	Passable
203030	0.898	3.266	-3.656	0.849	-4.575	-5.298	Good
204016	0.920	-4.266		0.874	-4.426		Good
204017	0.852	-29.627	-5.001	0.881	-23.234	2.966	Poor
204019	0.936	-0.082		0.883	-4.534		Good
204025	0.914	-5.003	-4.370	0.896	-4.849	-7.651	Good
204026	0.931	-4.993	-17.604	0.914	-5.430	-16.079	Satisfactory
204030	0.679	2.305	-38.898	0.547	2.238	-37.031	Passable
204031	0.805	-4.838		0.742	1.744		Satisfactory
204033	0.881	-4.237		0.801	-0.943		Good
204034	0.851	-4.982	-19.990	0.749	-8.339	-18.223	Satisfactory
204036	0.800	-3.953	-26.137	0.727	-1.456	-30.412	Satisfactory
204037	0.855	4.988	0.161	0.770	5.156	-0.878	Satisfactory
204041	0.945	1.007	-9.787	0.914	-3.585	-10.939	Good
204055	0.908	-3.361	0.050	0.888	0.182	-2.422	Good
204056	0.772	-4.997	-44.055	0.767	-22.332	-21.092	Poor
204067	0.944	4.272	1.852	0.927	1.190	0.202	Good
205002	0.876	-4.962		0.868	-5.034		Satisfactory
205006	0.951	-2.839	-4.994	0.924	-1.941	-7.039	Good
205008	0.954	2.538		0.946	2.932		Good
205012	0.889	-1.012		0.843	-0.570		Good
205014	0.932	-4.996		0.875	3.769		Good
206009	0.771	0.168	-28.889	0.758	-1.028	-29.367	Satisfactory
206014	0.667	1.519	-41.403	0.621	-2.888	-39.761	Satisfactory
206018	0.775	-4.107	-35.248	0.591	2.642	-36.970	Passable

206020	0.749	-4.989		0.722	-6.463		Satisfactory
206025	0.776	1.522	-40.874	0.555	-12.662	-33.951	Passable
206034	0.847	4.495		0.672	-2.250		Satisfactory
207006	0.885	-1.694		0.874	-3.327		Good
207012	0.924	-2.669	-4.947	0.887	-6.103	-9.189	Satisfactory
207013	0.948	1.986	-0.249	0.921	-0.308	2.313	Good
207014	0.936	-4.993		0.930	-4.419		Good
207015	0.783	-4.195		0.759	-4.682		Satisfactory
208002	0.622	-4.971		0.600	-3.703		Passable
208005	0.849	-4.254	-9.987	0.823	-4.038	-3.814	Good
208006	0.764	-4.999	-41.204	0.712	-4.457	-42.461	Satisfactory
208007	0.793	1.012	-33.544	0.710	1.096	-35.514	Satisfactory
208008	0.881	0.274		0.841	-0.455		Good
208009	0.812	-0.004		0.709	-3.017		Satisfactory
208012	0.901	1.864		0.881	4.129		Good
208015	0.937	0.975	-3.868	0.926	-1.741	-1.608	Good
208019	0.916	1.779		0.875	0.185		Good
208022	0.789	-0.509		0.414	-12.109		Passable
208026	0.674	1.807		0.530	-8.605		Passable
209001	0.759	-4.683	-37.881	0.746	-4.527	-37.777	Satisfactory
209002	0.789	-4.778	-15.991	0.784	-3.571	-21.311	Satisfactory
209006	0.886	-1.887	0.061	0.855	-1.287	-2.775	Good
210014	0.681	-1.716	-39.926	0.587	2.829	-33.907	Passable
210017	0.717	-4.805		0.606	-5.666		Satisfactory
210022	0.883	-4.162	-26.522	0.866	-3.498	-30.708	Good
210040	0.721	4.892		0.102	-0.706		Poor
210042	0.725	4.896	-35.974	0.657	2.219	-35.321	Satisfactory
210048	0.898	4.439		0.829	19.576		Poor
210061	0.658	-0.064		0.530	-9.396		Passable
210080	0.799	1.702	-19.672	0.537	-13.555	-20.232	Passable
210081	0.691	-1.176		0.603	6.122		Satisfactory
210082	0.512	4.613		0.398	-5.488		Poor
210088	0.894	1.894		0.637	5.444		Satisfactory
210091	0.805	-3.527		0.117	7.642		Poor
210092	0.874	4.974		0.595	-16.461		Poor
211008	0.883	-1.216	-16.946	0.856	-1.631	-14.960	Good
211013	0.914	-3.399		0.838	-3.308		Good
211014	0.906	4.677		0.859	0.816		Good
212018	0.817	4.772		0.293	-4.977		Poor
212021	0.812	4.957		0.686	-10.958		Passable
212028	0.869	-1.302		0.801	0.068		Good
212040	0.822	-2.168		0.704	-6.144		Satisfactory
212045	0.685	-2.329		0.358	-9.096		Passable
215002	0.844	-2.373		0.775	-3.591		Satisfactory
215004	0.870	-2.651		0.773	14.553		Passable
215005	0.864	-4.999		0.808	-5.309		Satisfactory
215008	0.921	-4.666		0.906	-3.251		Good
216004	0.926	4.981		0.884	4.354		Good
216009	0.572	4.874		0.180	11.612		Poor
218001	0.888	0.295	-19.964	0.849	-1.923	-18.923	Good
218002	0.938	2.302		0.803	-10.424		Passable
218006	0.764	4.965		0.723	3.141		Satisfactory
218007	0.931	0.341		0.923	-0.664		Good
219013	0.928	-2.165	-9.993	0.911	-3.236	-6.339	Good
219016	0.844	3.910		0.690	5.339		Satisfactory
219017	0.904	4.951		0.889	5.483		Satisfactory

220002	0.900	4.924	-4.220	0.783	-0.109	-3.975	Satisfactory
220003	0.787	-1.107		0.587	-2.028		Passable
220004	0.827	-3.885		0.557	0.739		Passable
221002	0.897	4.995		0.852	0.682		Good
221003	0.902	-1.499	-5.001	0.854	-1.572	-4.125	Good
221010	0.796	4.935		0.691	4.541		Satisfactory
222001	0.871	-0.685		0.714	6.861		Satisfactory
222004	0.873	-0.874	-4.903	0.806	2.968	7.015	Good
222007	0.575	-0.916		0.077	-2.442		Poor
222009	0.926	-4.718	-1.249	0.896	-0.962	-2.582	Good
222010	0.889	3.317	4.937	0.771	-2.124	16.294	Satisfactory
222011	0.930	-3.143	4.314	0.681	-14.619	10.839	Passable
222014	0.884	0.587		0.770	4.407		Satisfactory
222015	0.619	-0.833	1.960	0.554	1.889	0.847	Passable
222016	0.564	-1.078		0.476	-0.706		Poor
222017	0.609	3.642		0.425	1.803		Passable
401008	0.925	4.843		0.798	2.431		Satisfactory
401009	0.818	4.883	2.531	0.793	5.243	1.117	Satisfactory
401012	0.782	2.254	4.964	0.733	5.726	1.132	Satisfactory
401013	0.898	3.609	4.930	0.856	4.081	2.298	Good
401015	0.777	4.621	4.007	0.720	1.886	9.926	Satisfactory
401016	0.781	1.627		0.617	-2.441		Satisfactory
410033	0.015	-4.819	-4.705	-0.370	12.768	-21.662	Poor
410038	0.850	3.553	-2.275	0.820	3.789	-0.998	Good
410044	0.217	-4.925	-4.972	0.491	-7.621	-30.173	Poor
410047	0.835	-4.010		0.765	-7.939		Satisfactory
410048	0.848	4.881		0.711	-7.095		Satisfactory
410057	0.894	-1.251	4.318	0.879	-0.364	4.528	Good
410059	0.908	-0.295	-1.405	0.887	-0.748	-3.200	Good
410061	0.879	2.448		0.728	-1.984		Satisfactory
410067	0.811	-4.987		0.600	0.978		Satisfactory
410071	0.891	3.412		0.778	1.112		Satisfactory
410077	0.888	-4.913		0.656	-11.349		Passable
410096	0.893	-2.508		0.737	-2.118		Satisfactory
410097	0.587	4.932		0.356	2.993		Poor
410105	0.938	-4.188		0.911	-5.348		Satisfactory
410111	0.924	-3.236		0.898	-4.356		Good
410126	0.779	4.874		0.461	-17.003		Poor
410141	0.874	4.568		0.603	17.334		Poor
411003	0.809	-5.016		0.681	-12.161		Passable
412063	0.882	-1.600		0.769	-1.760		Satisfactory
412066	0.642	-4.986		0.505	3.129		Passable
412068	0.576	4.859		0.501	11.473		Poor
412071	0.665	4.326		-0.002	6.100		Poor
412072	0.780	3.819		0.621	-3.319		Satisfactory
412073	0.422	3.963		0.310	-5.060		Poor
412076	0.537	-4.754		0.369	-0.171		Poor
412080	0.683	1.712		0.297	11.628		Poor
412082	0.822	-4.894		0.757	-6.465		Satisfactory
412089	0.666	1.155		0.560	-7.642		Passable
412092	0.444	-2.011		0.310	-13.764		Poor
412096	0.884	2.994		0.779	1.734		Satisfactory
412110	0.729	1.103		0.704	-0.953		Satisfactory
416008	0.658	4.938		0.525	0.241		Passable
416020	0.755	4.094		0.567	3.111		Passable
416021	0.801	4.757		0.706	1.548		Satisfactory

416022	0.749	4.952	-31.447	0.571	4.224	-33.521	Passable
416023	0.703	-3.738	-5.016	0.654	-1.596	-10.764	Satisfactory
416035	0.768	-4.994		0.709	-2.394		Satisfactory
416036	0.774	4.512		-0.109	19.003		Poor
418005	0.772	-4.894	-9.971	0.735	11.688	-24.722	Passable
418015	0.834	-4.980	-19.139	0.809	-6.434	-26.631	Satisfactory
418016	0.548	4.943		0.336	-10.713		Poor
418017	0.687	-4.980	-9.722	0.547	11.822	-12.274	Passable
418020	0.424	4.608	-52.714	0.364	3.384	-49.203	Poor
418021	0.638	-0.965	-31.059	0.482	-11.360	-32.299	Passable
418024	0.705	5.007	-41.023	0.603	-0.765	-43.030	Satisfactory
418025	0.611	4.378		0.166	-4.619		Poor
418027	0.851	-2.550	-26.833	0.828	0.549	-29.612	Good
418032	0.768	5.037		0.542	-8.154		Passable
418033	0.720	4.348		0.423	-5.032		Passable
419010	0.769	-4.717		0.725	-4.379		Satisfactory
419029	0.788	3.739		0.691	11.346		Passable
419035	0.888	4.984		0.815	8.628		Satisfactory
419044	0.796	-0.529	-4.871	0.600	1.216	16.320	Satisfactory
419047	0.905	-4.855		0.825	-13.309		Passable
419050	0.798	-4.353		0.628	0.464		Satisfactory
419053	0.419	-4.992	-4.795	0.661	-12.646	-35.074	Poor
419054	0.777	-2.730	-10.044	0.652	0.611	-28.900	Satisfactory
419055	0.699	4.871		0.598	2.230		Passable
419072	0.867	1.228	-4.059	0.311	9.028	-2.708	Passable
419076	0.843	4.484		0.678	-2.195		Satisfactory
420003	0.879	3.790	-4.725	0.822	3.511	-1.945	Good
420010	0.852	4.899		0.049	18.715		Poor
421018	0.883	-1.758		0.853	-0.855		Good
421026	0.821	-0.061	-25.916	0.760	-4.246	-22.011	Satisfactory
421036	0.756	-5.043	-9.892	0.722	-3.787	-13.592	Satisfactory
421048	0.899	-4.861		0.764	-14.752		Passable
421050	0.921	4.593	-4.994	0.894	1.198	0.803	Good
421055	0.883	4.970		0.838	0.068		Good
421056	0.525	4.829		0.211	1.766		Poor
421066	0.715	1.404		0.585	6.453		Passable
421068	0.490	5.013		0.145	-13.103		Poor
421076	0.920	4.975		0.167	25.471		Poor
421084	0.757	5.006	-55.322	0.291	-34.312	-18.114	Poor
421100	0.802	4.987		0.700	3.443		Satisfactory
421101	0.869	4.867		0.615	6.304		Satisfactory
421104	0.897	3.164		0.860	1.706		Good
421106	0.831	4.967		0.702	-4.331		Satisfactory
421125	0.835	3.052		0.353	-12.099		Passable
421126	0.720	4.683		-0.090	-24.186		Poor
Northern Territory							
<i>Gauge</i>	<i>Cal. E</i>	<i>Cal. TVOL</i>	<i>Cal. CV</i>	<i>Val. E</i>	<i>Val. TVOL</i>	<i>Val. CV</i>	<i>Class</i>
60046	0.912	-4.934		0.831	5.471		Satisfactory
8140008	0.850	1.887		0.774	2.423		Satisfactory
8140159	0.783	-4.939	-4.427	0.739	-6.163	-21.335	Satisfactory
8200045	0.917	-2.413	-19.242	0.893	-6.405	-16.397	Satisfactory
8210007	0.790	-1.257		0.709	3.470		Satisfactory
Queensland							
<i>Gauge</i>	<i>Cal. E</i>	<i>Cal. TVOL</i>	<i>Cal. CV</i>	<i>Val. E</i>	<i>Val. TVOL</i>	<i>Val. CV</i>	<i>Class</i>
110003	0.931	-4.950	-14.914	0.921	-6.080	-12.207	Satisfactory
111007	0.885	-0.037	4.284	0.775	-1.188	4.917	Satisfactory

112003	0.941	-4.917	1.219	0.935	-4.379	-0.015	Good
117002	0.807	-5.021	-9.856	0.696	-6.855	-8.540	Satisfactory
119003	0.930	4.966	3.196	0.892	3.611	-1.197	Good
120216	0.946	3.879	-4.862	0.933	2.864	0.081	Good
121002	0.941	-0.108	-4.937	0.909	-1.535	-1.401	Good
122003	0.573	-3.343	-4.770	0.246	-3.863	0.866	Poor
125002	0.949	2.322	-0.765	0.914	2.682	-1.975	Good
129001	0.817	-3.298	-35.817	0.798	-3.648	-33.989	Satisfactory
130319	0.830	-1.738	-4.737	0.763	3.123	-15.621	Satisfactory
132001	0.915	-4.992	-4.998	0.886	0.354	-3.071	Good
135002	0.963	-3.767	4.805	0.944	0.254	0.775	Good
136202	0.844	-5.065	-9.646	0.800	-6.762	-13.932	Satisfactory
136315	0.677	-4.988	-4.780	0.593	-16.331	-19.068	Poor
142001	0.939	-0.230	-4.998	0.922	-1.958	-7.665	Good
143110	0.911	-1.142	-5.004	0.883	0.343	-4.375	Good
145011	0.821	-3.742	-25.612	0.679	-5.789	-19.544	Satisfactory
145018	0.851	4.101	-4.983	0.822	-0.127	-3.292	Good
145102	0.911	-3.164	-0.311	0.883	-2.113	1.650	Good
South Australia							
<i>Gauge</i>	<i>Cal. E</i>	<i>Cal. TVOL</i>	<i>Cal. CV</i>	<i>Val. E</i>	<i>Val. TVOL</i>	<i>Val. CV</i>	<i>Class</i>
239519	0.836	4.543	-4.892	0.799	3.860	-3.502	Satisfactory
426504	0.925	4.843	1.856	0.900	3.706	3.811	Good
502502	0.943	4.959		0.925	3.615		Good
505504	0.772	-5.000	-9.623	0.597	0.963	-35.151	Passable
505517	0.699	4.904		0.452	6.233		Passable
505532	0.854	4.939		0.309	-18.933		Poor
506500	0.649	-4.082	-5.007	0.721	3.451	4.799	Satisfactory
507500	0.759	0.228	-4.681	0.675	4.284	-22.377	Satisfactory
507501	0.578	-0.302	-19.982	0.574	3.257	-33.016	Poor
509503	0.889	-3.158	2.361	-5.416	105.663	64.272	Poor
513501	0.846	-4.912	-4.803	0.768	-1.332	-5.173	Satisfactory
Tasmania							
<i>Gauge</i>	<i>Cal. E</i>	<i>Cal. TVOL</i>	<i>Cal. CV</i>	<i>Val. E</i>	<i>Val. TVOL</i>	<i>Val. CV</i>	<i>Class</i>
3080003	0.676	-10.993		0.652	-12.364		Passable
3120001	0.891	-0.809		0.852	-3.386		Good
3180010	0.891	0.102		0.851	0.002		Good
3190200	0.926	-2.107		0.862	0.469		Good
318900	0.877	-3.114		0.849	-0.311		Good
303203	0.855	-4.979	-22.914	0.842	-11.346	-15.663	Passable
307201	0.817	-15.760	6.383	0.816	-15.887	6.801	Poor
319201	0.951	-1.674	-4.604	0.942	-1.999	-6.782	Good
304201	0.841	0.567	-19.979	0.541	-2.949	-12.870	Passable
314207	0.961	-0.643	2.608	0.958	-0.574	2.972	Good
318852	0.922	-4.114		0.895	-4.309		Good
302208	0.753	-2.630	-25.235	0.726	-3.850	-26.559	Satisfactory
319204	0.943	-1.927	-9.959	0.934	-1.640	-11.199	Good
318311	0.746	0.947		0.614	5.857		Satisfactory
302200	0.877	-4.988	-19.595	0.868	0.035	-25.265	Good
304206	0.709	-9.998	53.711	0.683	-10.136	65.695	Passable
Victoria							
<i>Gauge</i>	<i>Cal. E</i>	<i>Cal. TVOL</i>	<i>Cal. CV</i>	<i>Val. E</i>	<i>Val. TVOL</i>	<i>Val. CV</i>	<i>Class</i>
221201	0.834	-4.026	-4.943	0.768	-0.645	-2.654	Satisfactory
221204	0.873	-3.475	-9.919	0.793	-2.580	-11.806	Satisfactory
221210	0.913	4.870	-3.722	0.871	0.665	0.274	Good
222202	0.900	-0.426	-2.858	0.870	-0.134	1.046	Good
222206	0.781	-0.967	-4.994	0.733	1.919	-4.884	Satisfactory

222213	0.708	4.494	4.956	0.585	6.345	23.170	Passable
223202	0.749	2.829	-4.419	0.607	0.758	10.190	Satisfactory
223207	0.804	-2.104	-4.809	0.756	-4.498	-4.147	Satisfactory
224201	0.725	4.609	4.982	0.672	5.985	17.958	Satisfactory
224207	0.792	4.930	5.002	0.776	4.939	6.632	Satisfactory
224209	0.881	-4.893	-18.716	0.828	-0.306	-22.521	Good
225213	0.692	-3.116	-19.998	0.552	-8.408	-12.110	Passable
225217	0.885	2.258	-4.719	0.819	-2.569	-5.871	Good
225218	0.713	-3.924	-19.947	0.686	-1.678	-34.263	Satisfactory
225219	0.747	4.927	4.917	0.718	4.395	8.721	Satisfactory
226007	0.790	-1.773	-4.912	0.746	-3.040	-5.794	Satisfactory
226204	0.710	-4.888	-4.991	0.507	-2.701	6.678	Passable
226218	0.874	-4.767	-10.002	0.853	-2.238	-14.350	Good
226405	0.880	1.708	-4.956	0.849	1.537	-3.715	Good
226406	0.791	4.935	4.991	0.776	5.507	5.409	Satisfactory
226410	0.900	3.346	-3.614	0.880	2.028	0.544	Good
227200	0.836	-1.334	-4.936	0.812	-2.115	-0.028	Good
227202	0.922	3.057	4.892	0.908	3.071	2.924	Good
227211	0.845	0.964	-3.443	0.802	-0.998	4.371	Good
227219	0.935	-1.457	-0.586	0.928	-1.401	-0.017	Good
228203	0.868	-4.812	-24.903	0.748	-2.982	-31.784	Satisfactory
228206	0.582	-4.992	-4.771	0.465	-6.455	-9.041	Poor
228212	0.634	-5.001	-4.775	0.585	-3.548	-19.886	Passable
229215	0.900	-1.080	-4.262	0.866	-2.134	-3.153	Good
230205	0.884	4.944	-2.466	0.859	3.788	-1.927	Good
231213	0.849	-4.951	-4.877	0.829	-4.584	-3.020	Good
233215	0.824	3.006	-2.591	0.772	4.168	0.795	Satisfactory
233223	0.717	2.608	-3.915	0.560	4.369	-10.815	Passable
234200	0.688	-1.483	-4.910	0.497	-6.306	6.864	Passable
234203	0.794	4.847	-4.007	0.761	3.042	3.222	Satisfactory
235203	0.890	4.897	-1.339	0.852	6.422	-0.859	Satisfactory
235211	0.858	4.983	3.877	0.819	5.410	7.157	Satisfactory
236203	0.718	4.030	-5.003	0.609	6.056	8.145	Satisfactory
236205	0.876	1.687	4.992	0.845	2.211	3.488	Good
236212	0.849	4.075	4.828	0.780	0.403	8.785	Satisfactory
237200	0.868	-2.004	-4.675	0.837	-3.177	-2.871	Good
237205	0.842	-2.329	-0.502	0.790	-1.101	2.130	Satisfactory
237206	0.767	4.882	-2.679	0.679	5.788	10.326	Satisfactory
238223	0.886	2.764	4.630	0.865	3.890	8.811	Good
401203	0.607	4.231	4.975	0.524	4.000	16.222	Passable
401210	0.864	-1.293	0.387	0.833	-0.546	4.393	Good
401212	0.845	0.560	4.895	0.815	-0.061	4.532	Good
402200	0.797	-1.477	-4.941	0.510	-2.214	1.780	Passable
402204	0.861	0.134	-4.933	0.815	1.232	-0.239	Good
402206	0.786	3.406	-1.947	0.721	3.426	0.937	Satisfactory
402406	0.660	-4.989	4.542	0.622	-3.483	12.285	Satisfactory
403205	0.902	3.224	-2.118	0.883	2.521	0.086	Good
403206	0.926	2.601	1.368	0.917	2.820	3.168	Good
403213	0.887	2.153	2.487	0.851	1.629	3.241	Good
403214	0.826	4.318	-2.012	0.799	1.996	2.708	Satisfactory
403217	0.948	-1.487	-4.961	0.945	-1.504	-5.773	Good
403224	0.871	1.043	2.766	0.814	1.944	-2.203	Good
403226	0.949	1.966	2.867	0.929	3.122	-2.651	Good
404208	0.888	1.874	-2.532	0.856	2.933	-1.984	Good
405205	0.729	-1.849	-4.468	0.701	-1.417	-4.465	Satisfactory
405209	0.907	-3.052	-4.988	0.903	-3.623	-11.843	Good

405214	0.824	1.284	-4.198	0.780	1.421	-4.284	Satisfactory
405219	0.932	-4.426	-4.991	0.928	-2.628	-7.836	Good
405226	0.892	4.848	4.165	0.842	3.502	4.630	Good
405228	0.903	5.001	4.896	0.843	3.842	11.345	Good
405229	0.800	0.600	-4.938	0.746	-0.048	-5.321	Satisfactory
405237	0.946	2.014	4.131	0.914	2.518	2.452	Good
406213	0.928	4.502	-2.530	0.907	3.537	0.390	Good
406214	0.912	4.635	-4.575	0.899	3.893	-1.216	Good
407220	0.803	1.915	2.760	0.710	3.283	2.795	Satisfactory
407221	0.854	-2.152	-4.981	0.822	1.105	-4.524	Good
407236	-0.044	-4.851	-4.974	0.383	-1.303	17.474	Poor
407253	0.807	4.381	-4.875	0.740	-7.083	-6.356	Satisfactory
408202	0.814	4.854	-4.779	0.790	4.218	4.293	Satisfactory
415207	0.780	-0.350	4.324	0.719	3.827	4.824	Satisfactory
Western Australia							
<i>Gauge</i>	<i>Cal. E</i>	<i>Cal. TVOL</i>	<i>Cal. CV</i>	<i>Val. E</i>	<i>Val. TVOL</i>	<i>Val. CV</i>	<i>Class</i>
601001	0.433	4.893	-63.856	-0.034	28.469	-26.382	Poor
603004	0.893	4.925		0.806	-0.454		Good
603136	0.795	4.919	-1.517	0.733	4.751	2.348	Satisfactory
604001	0.758	4.983		0.740	3.320		Satisfactory
606001	0.847	5.013	-0.795	0.773	5.311	0.189	Satisfactory
608151	0.946	4.641	4.582	0.916	7.328	11.741	Satisfactory
610001	0.948	2.898	-5.028	0.904	2.612	-2.911	Good
611111	0.897	4.928	2.343	0.846	9.485	9.425	Satisfactory
613002	0.905	-0.957	-3.024	0.880	-3.455	-2.345	Good
614196	0.942	4.616	-0.278	0.925	6.518	-3.168	Satisfactory

Appendix 3

Plots of estimated versus recorded streamflow for both the calibration and cross validation and a monthly time series plot of recorded, calibration and cross validation streamflow for eight example stations.

STATION
(505532) LIGHT RIVER @ Mingays Waterhole

Gauge	Cal. E	Cal. TVOL	Cal. CV	Val. E	Val. TVOL	Val. CV	Class
505532	0.854	4.939		0.309	-18.933		Poor

Calibration

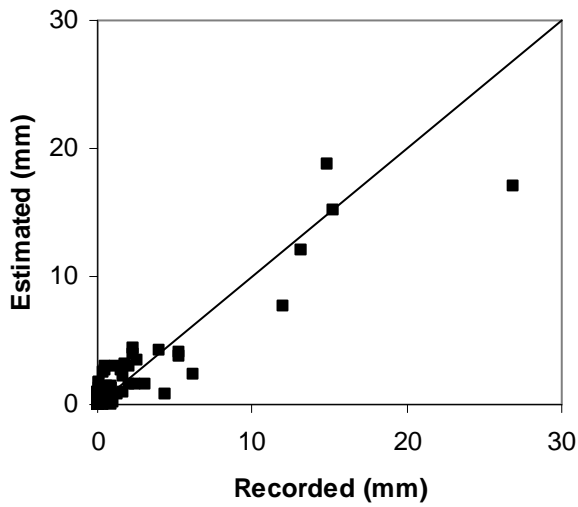

Validation

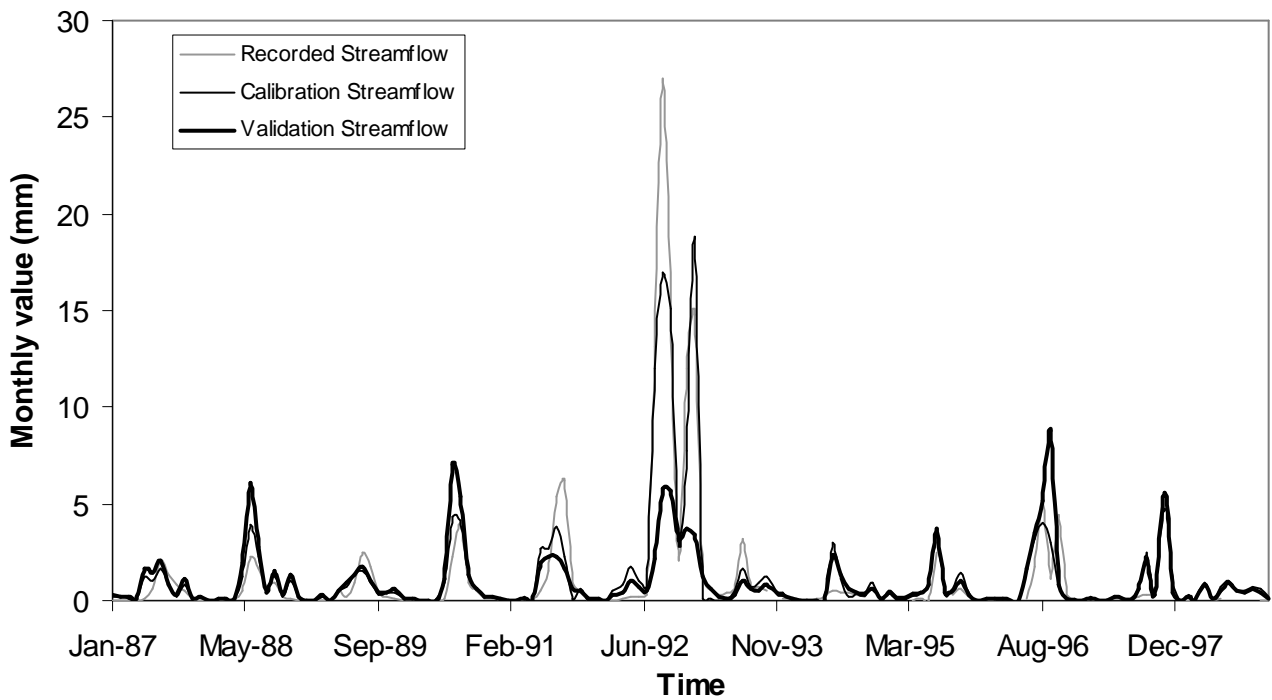
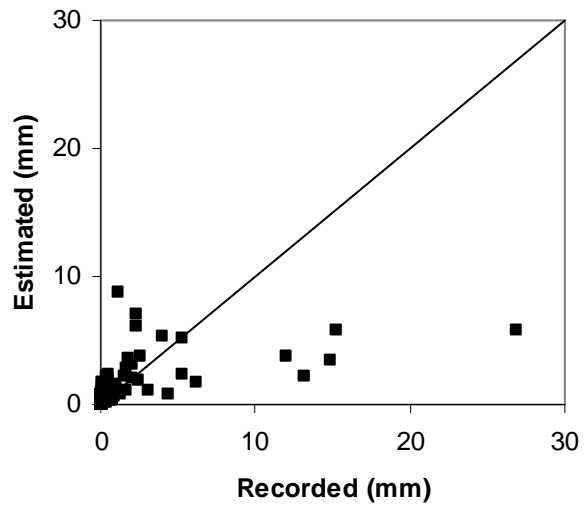

STATION
(601001) Young River @ Neds Corner

Gauge	Cal. E	Cal. TVOL	Cal. CV	Val. E	Val. TVOL	Val. CV	Class
601001	0.433	4.893	-63.856	-0.034	28.469	-26.382	Poor

Calibration

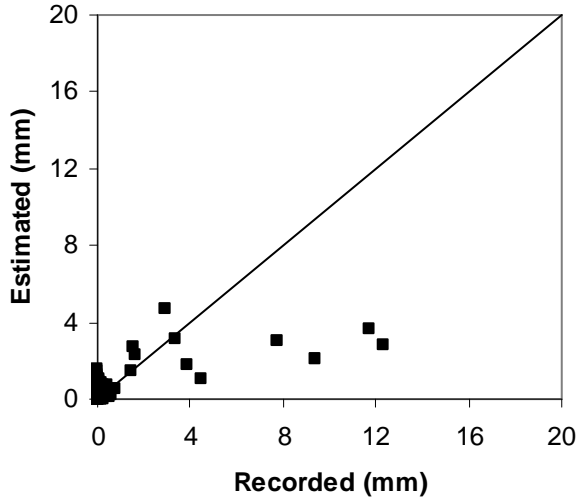

Validation

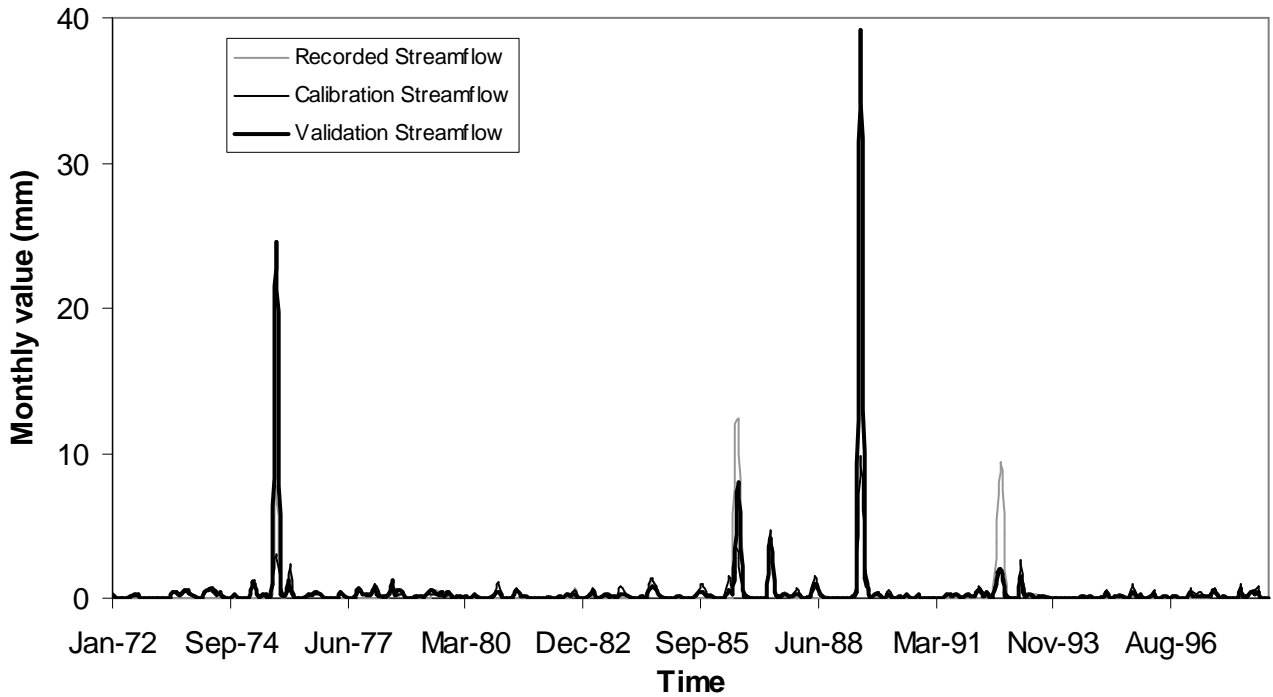
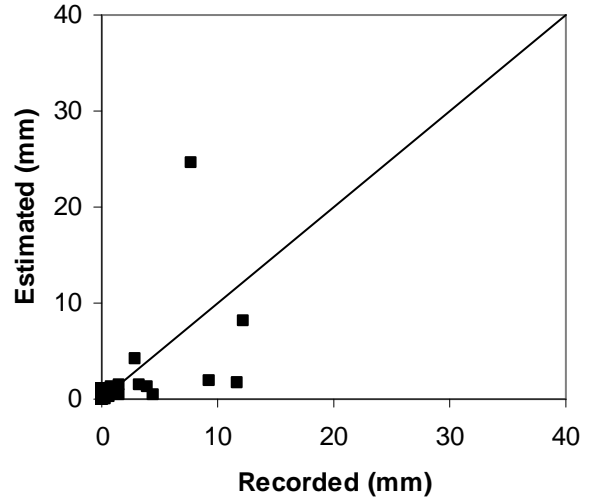

STATION
(412089) COOKS VALE CREEK @ PEELWOOD

Gauge	Cal. E	Cal. TVOL	Cal. CV	Val. E	Val. TVOL	Val. CV	Class
412089	0.666	1.155		0.560	-7.642		Passable

Calibration

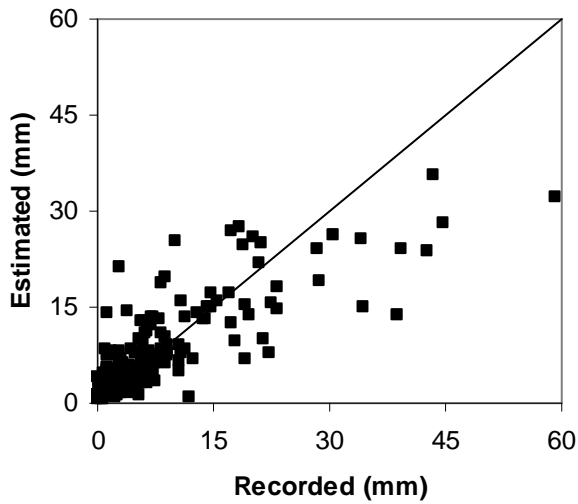

Validation

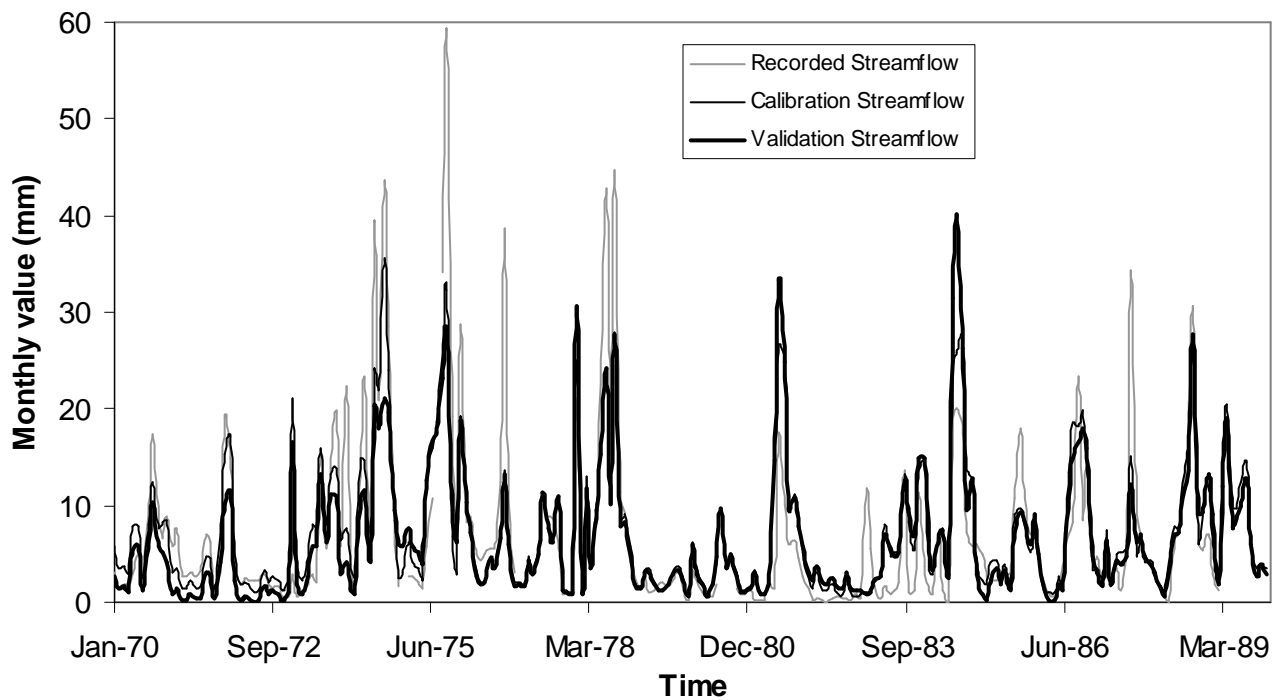
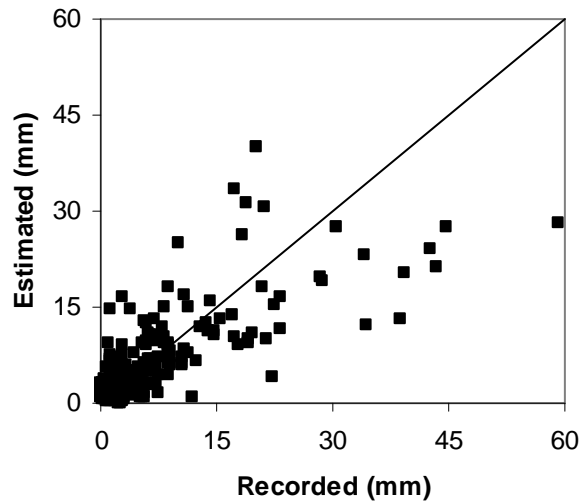

STATION
(419072) BARADINE CREEK @KIENBRI NO.2

Gauge	Cal. E	Cal. TVOL	Cal. CV	Val. E	Val. TVOL	Val. CV	Class
419072	0.867	1.228	-4.059	0.311	9.028	-2.708	Passable

Calibration

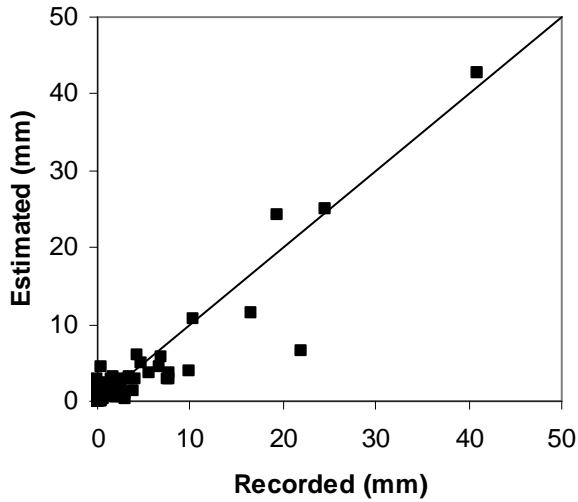

Validation

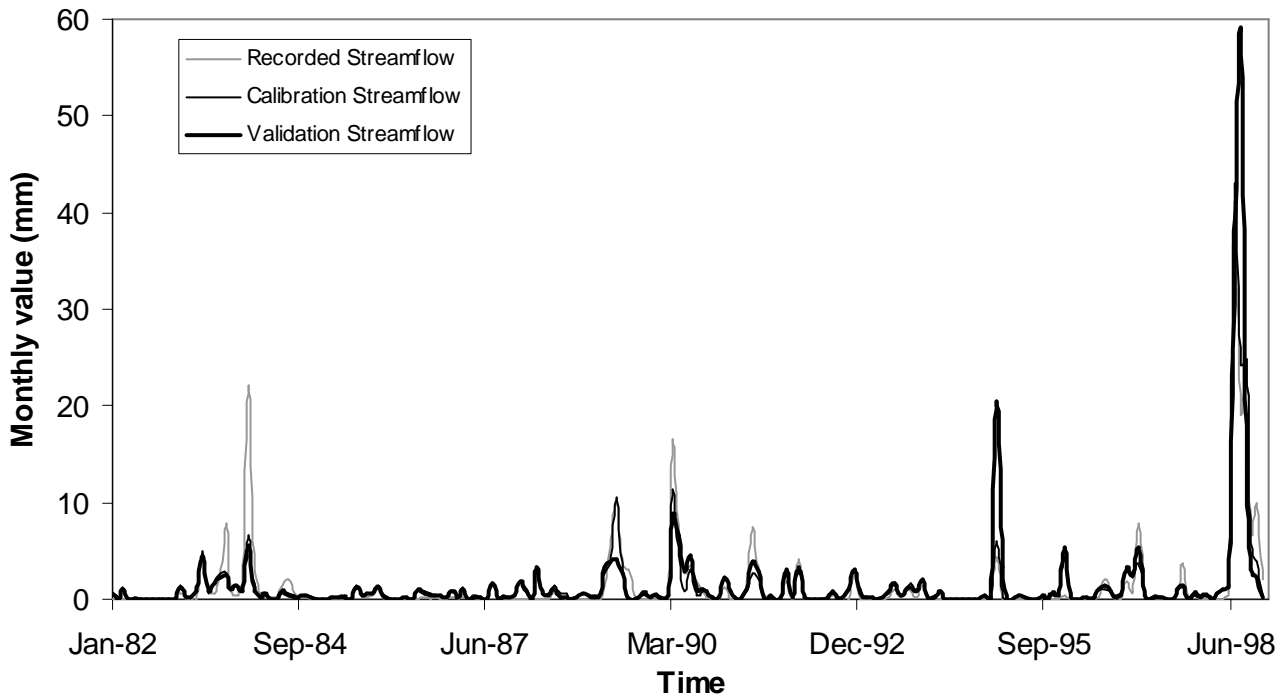
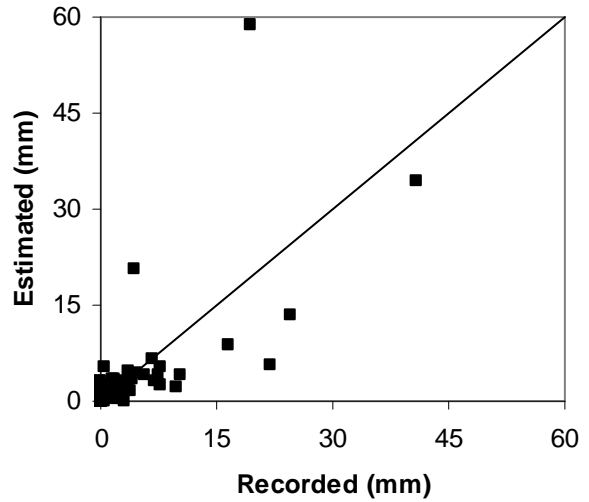

STATION

(8140159) Seventeen Mile Ck @ Waterfall View

Gauge	Cal. E	Cal. TVOL	Cal. CV	Val. E	Val. TVOL	Val. CV	Class
8140159	0.783	-4.939	-4.427	0.739	-6.163	-21.335	Satisfactory

Calibration

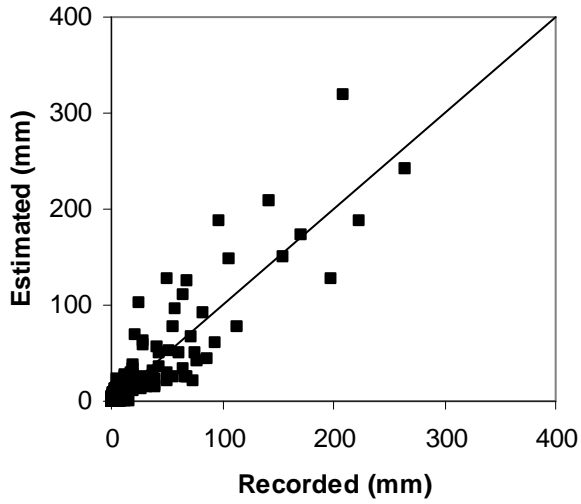

Validation

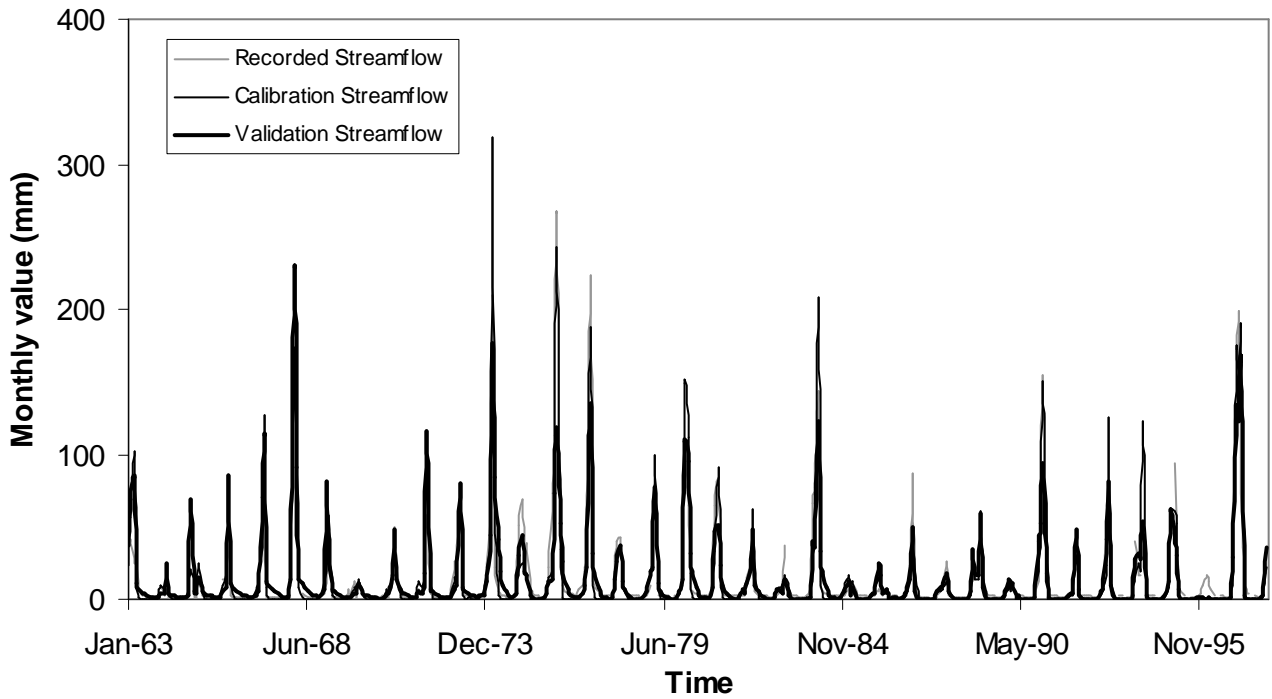
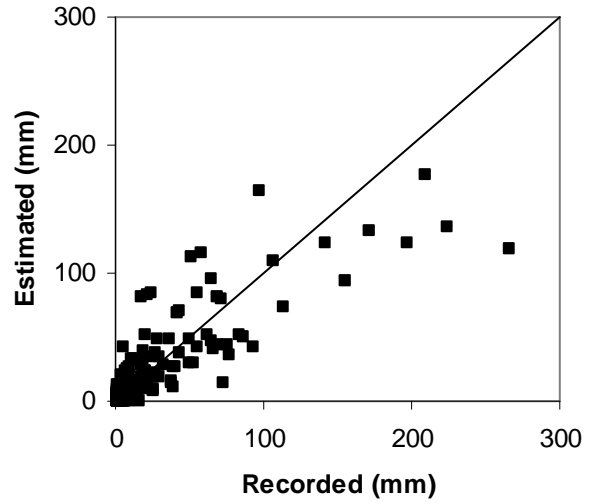

STATION
(117002) Black R @ Bruce Highway

Gauge	Cal. E	Cal. TVOL	Cal. CV	Val. E	Val. TVOL	Val. CV	Class
117002	0.807	-5.021	-9.856	0.696	-6.855	-8.540	Satisfactory

Calibration

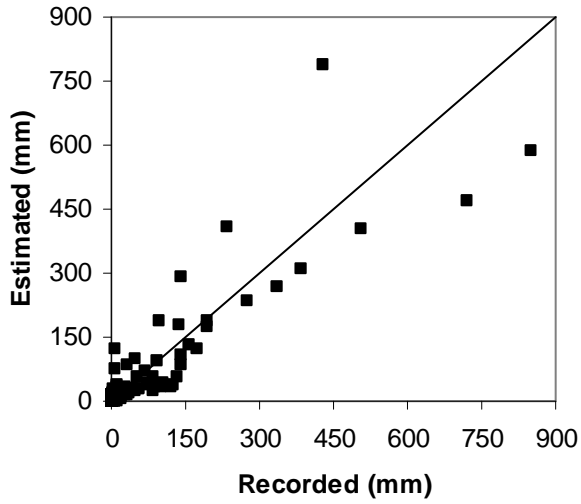

Validation

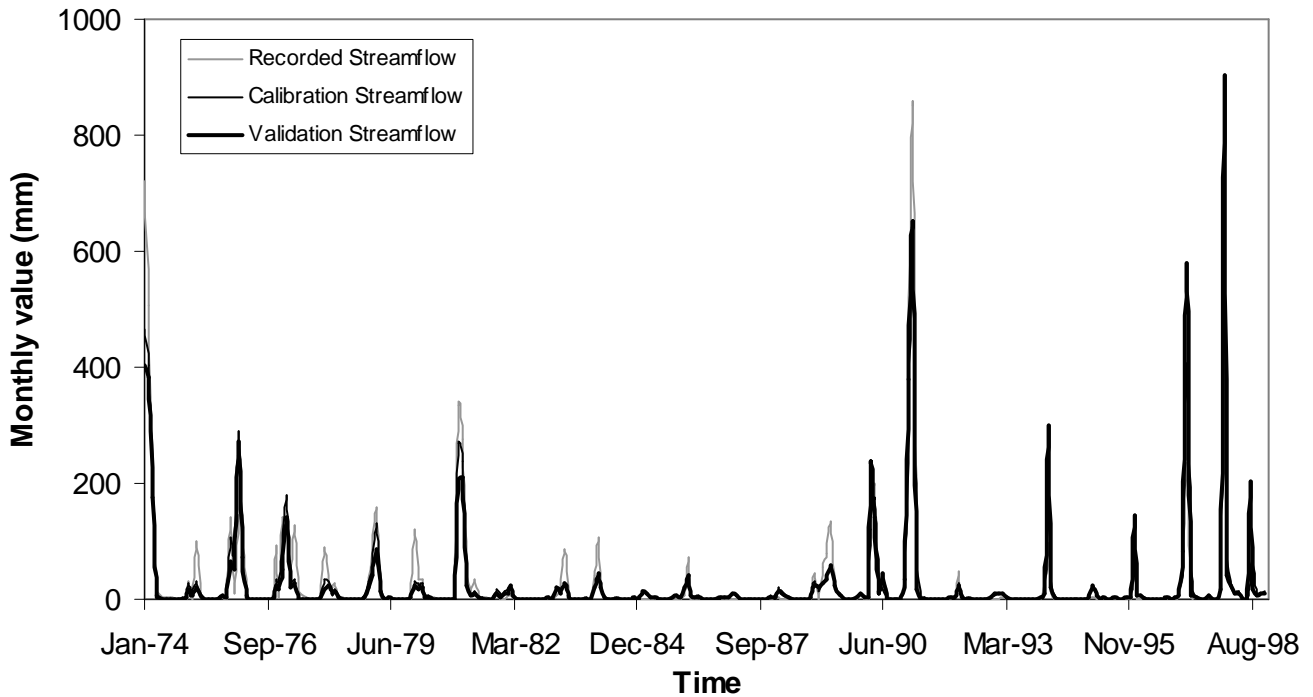
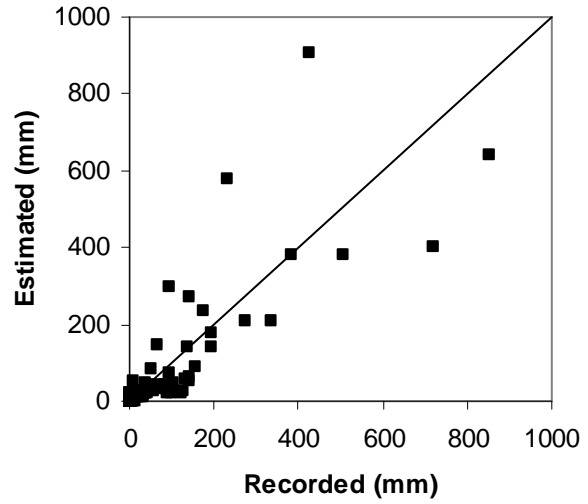

STATION
(314207) LEVEN River @ d/s BANNONS BRIDGE

Gauge	Cal. E	Cal. TVOL	Cal. CV	Val. E	Val. TVOL	Val. CV	Class
314207	0.961	-0.643	2.608	0.958	-0.574	2.972	Good

Calibration

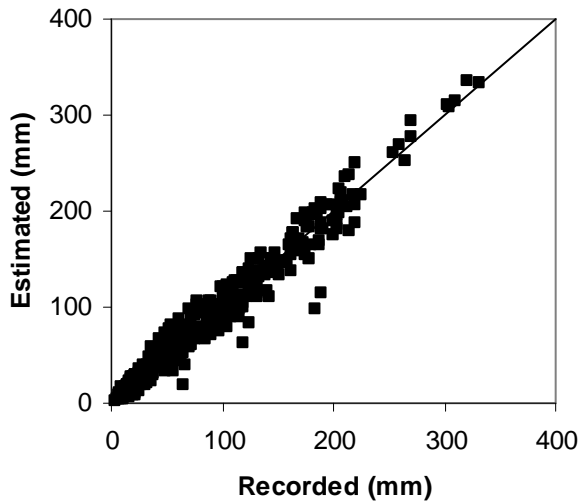

Validation

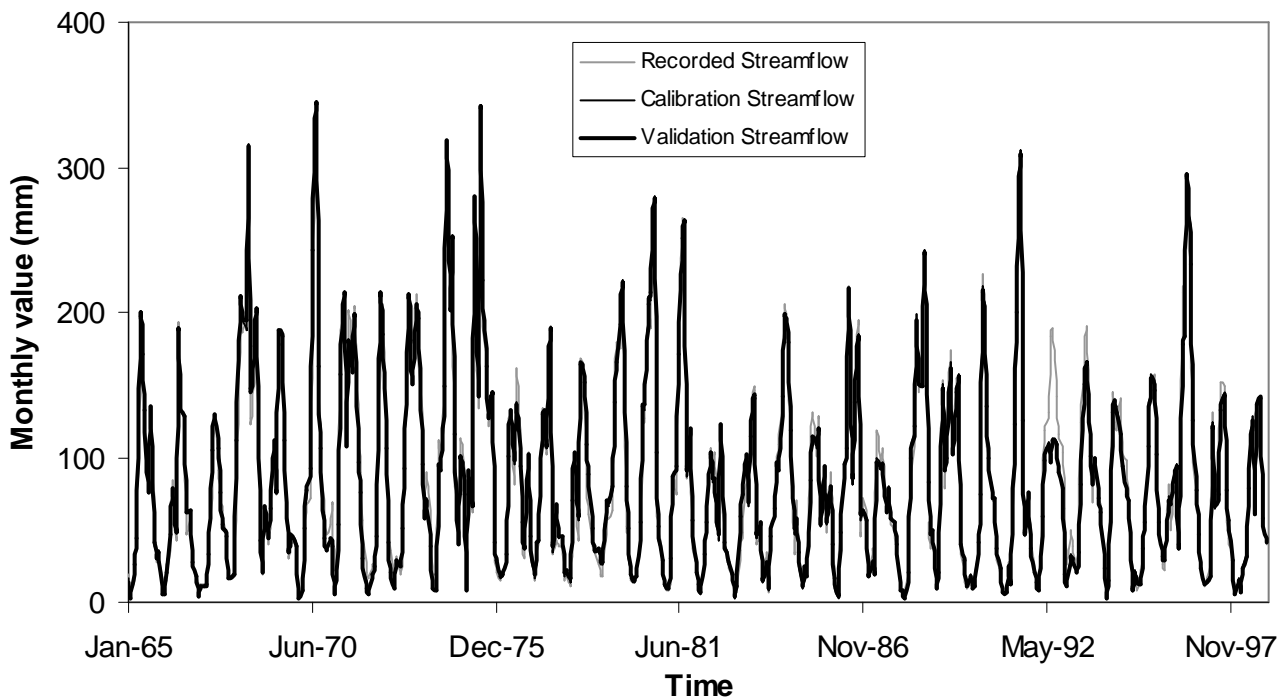
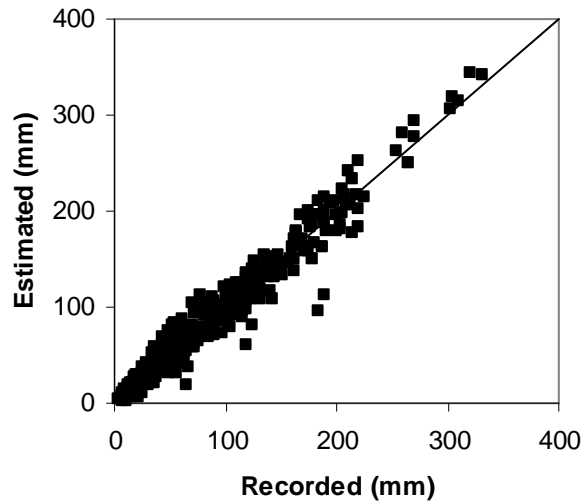

STATION
(225217) Barkly River @ Glencairn

Gauge	Cal. E	Cal. TVOL	Cal. CV	Val. E	Val. TVOL	Val. CV	Class
225217	0.885	2.258	-4.719	0.819	-2.569	-5.871	Good

Calibration

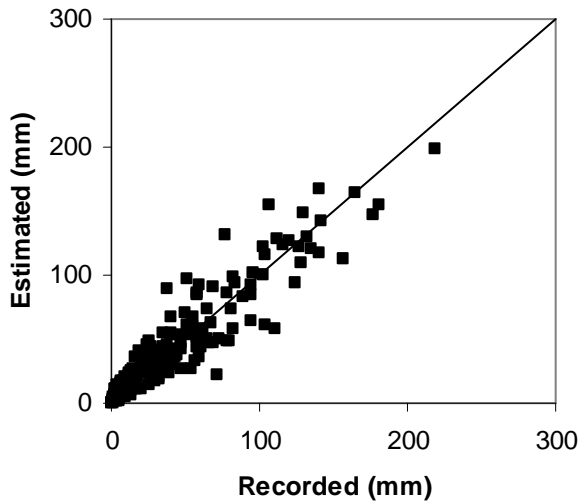

Validation

