

SPANWISE PERIODICITY AND THE EXISTENCE OF VERY LARGE SCALE COHERENCE IN TURBULENT BOUNDARY LAYERS

Nick Hutchins, Bharath Ganapathisubramani*, Ivan Marusic

Aerospace Engineering and Mechanics,
University of Minnesota
107 Akerman Hall, 110 Union St SE
Minneapolis, Minnesota 55455, USA
hutchins@aem.umn.edu, marusic@aem.umn.edu

ABSTRACT

Multiple plane stereo PIV results and data from a rake of ten hot-wire probes are used to investigate the largest scale structures in the log and wake regions of a zero-pressure-gradient turbulent boundary layer. Vector fields from streamwise-spanwise plane stereo PIV reveal long low- and high-speed regions, with a length that often exceeds the viewing window ($> 2\delta$). Instantaneously, a remarkable degree of spanwise organisation is also evident in these fields. This manifests as a persistent spanwise stripiness in the u component of the PIV vector field. Almost all trace of this spanwise organisation is lost in the mean statistics, presumably due to the multitude of scales that are naturally present in wall-bounded turbulence. A ‘de-jittering’ technique has been developed, whereby the instantaneous vector fields are sorted according to dominant spanwise Fourier modes. By applying statistical tools to the sorted subsets, we are able to extract a clear view of the spanwise organisation. We show that the instantaneous spanwise behaviour of the streamwise velocity component (u) is well described by single spanwise sinusoidal modes extending a considerable distance in the wall-normal and streamwise directions. Results are confirmed in the various PIV data-sets. Since the PIV fails to adequately capture the full streamwise extent of the low-speed regions, a rake of hot-wire probes is also employed to capture a continuous view of the spanwise coherence. It is found that the low-speed regions are in fact extremely persistent in the streamwise direction, often exceeding 20δ in length. The fact that these long features meander appreciably in the spanwise direction will limit the overall streamwise length-scale as witnessed by a single probe or single point statistic. For instance, in the log region of turbulent boundary layers, premultiplied one-dimensional spectra of the streamwise velocity component ($k_x\Phi_{uu}$) seem to reveal a peak characteristic lengthscale of $5 - 7\delta$.

INTRODUCTION

Over the past four decades there has been a general emergent consensus on the existence of streaky structures in the near-wall region of turbulent boundary layers. These features are found to possess a characteristic spanwise streak spacing of approximately 100 viscous wall units (Kline *et al.*, 1967; see

Robinson, 1991 for review). Further from the wall, two-point correlations obtained from hot-wire data (Wark *et al.*, 1991; Mclean, 1990) have consistently indicated a larger spanwise structure in the log and wake regions (scaling on boundary layer thickness δ and increasing in size with distance from the wall). Prior to the advent of PIV, the precise form of these log-region structures was largely unproven, although statistics based on fluctuating u signals at these heights (particularly the peak in the pre-multiplied energy spectra $k_x\Phi_{uu}$ and the long tails in the autocorrelations) had long hinted at the existence of highly elongated regions of uniform streamwise momentum. PIV measurements in the streamwise-spanwise plane revealed that the log region is indeed characterised by its own streaky structure (e.g. Tomkins & Adrian, 2003), albeit of a much larger scale. Long regions of streamwise momentum deficit are found, with high-speed fluid seeming to fill the separation between neighboring motions. Further investigations have suggested that these long modes of uniform momentum deficit are associated with packets of hairpin vortices (Adrian *et al.*, 2000; Tomkins & Adrian, 2003; Ganapathisubramani *et al.*, 2003). It was found that the elongated low-speed regions are flanked by vortical motions (believed to be the necks of hairpin structures) and that together these features are dominant contributors to the overall Reynolds shear stress at this height (Ganapathisubramani *et al.*, 2003). The low-speed regions are of the order $0.3 - 0.5\delta$ wide, and typically have a length that exceeds the streamwise extent of the PIV frame (usually limited to $\sim 2\delta$). There is some evidence in the literature that these features can attain very large streamwise dimensions in pipe and channel flows. From hot-film measurements in pipe flows, Kim & Adrian (1999) found that streamwise energetic modes can extend up to 12-14 pipe radii. More recent analysis of large numerical domain DNS results (in particular 2D spectra) have shown that in the log region, Φ_{uu} energy can reside in very long streamwise modes (certainly > 20 channel half heights) for larger k_y bands (del Álamo & Jiménez, 2003).

FACILITY

These scales are investigated using three separate data-sets, all of which were obtained at the same approximate Reynolds number ($Re_\tau \approx 1100$) and in the same flow facility (open return suction-type boundary layer wind-tunnel of working section $4.7 \times 1.2 \times 0.3$ m). The data-sets comprise:

- inclined plane cross-stream PIV measurements at both 45° and 135° to the x-axis (only 45° case analysed here).

* now at
Center of Aeromechanics Research
The University of Texas at Austin
Austin, Texas 78712, USA
bharath@mail.utexas.edu

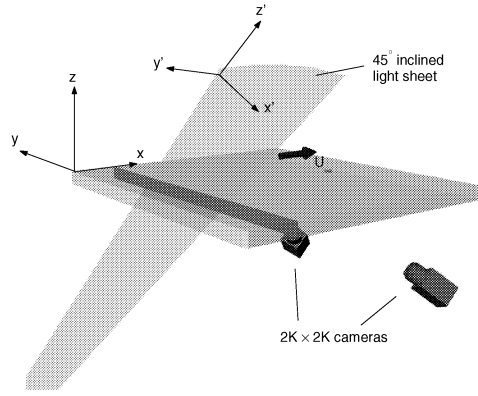

Figure 1: Basic set-up for 45° inclined plane PIV, showing viewing window, laser sheet, camera location and axis system.

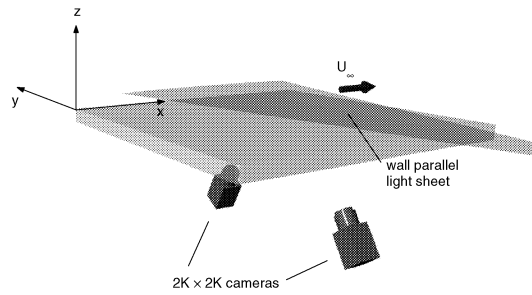

Figure 2: Basic set-up for streamwise / spanwise plane PIV, showing viewing window, laser sheet and camera location.

- Streamwise / spanwise plane PIV measurements.
- Hot-wire measurements from a rake of 10 single wire sensors covering approximately 1.02δ in the spanwise direction.

Throughout this paper, the axis system x , y and z refer to the streamwise, spanwise and wall-normal directions, with u , v and w describing the respective fluctuating velocity components.

Inclined-plane stereo PIV

In what is essentially a reprise of the well known visualizations by Head & Bandyopadhyay (1981), the laser light sheet and image plane were arranged in a cross-stream orientation inclined at 45° to the x -axis. Figure 1 shows the experimental configuration and transformed axis system. The out-of-plane direction is referred to as x' , spanwise ordinates are unchanged ($y' = y$) and the third ordinate z' is defined appropriately by the right-hand rule. The velocity components along the x' , y' and z' axes are denoted as u_{45} , v_{45} and w_{45} respectively. It is these components that are measured during the experiment. Streamwise, spanwise and wall-normal velocity components are recovered from simple trigonometric conversion.

$$u = \frac{u_{45} + w_{45}}{\sqrt{2}} \quad v = v_{45} \quad w = \frac{w_{45} - u_{45}}{\sqrt{2}} \quad (1)$$

Full details of these experiments are given in Hutchins *et al.*

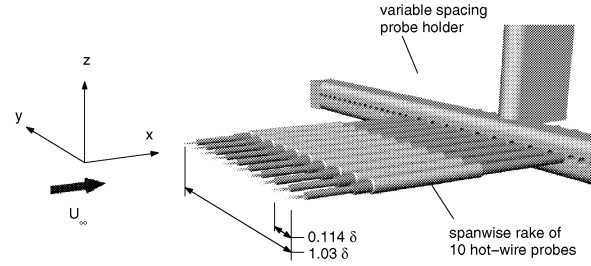

Figure 3: The spanwise rake of 10 single hot-wire sensors .

(2005). The actual data analysed here are from an earlier set with a wider field-of-view, taken at $Re_\tau = 1142$ (as described in Ganapathisubramani *et al.*, 2005).

Wall-parallel plane stereo PIV

For these experiments, the seeded boundary layer is illuminated by a laser sheet parallel to the glass wall at $z^+ = 150$ ($z/\delta = 0.14$). A stereo pair of cameras, viewing from below, image a streamwise / spanwise measurement domain. (see Figure 2). Full details are given in Ganapathisubramani *et al.* (2003, 2005).

Spanwise hot-wire array

A spanwise rake of ten single sensor hot-wire probes was inserted into the boundary layer at a height from the wall of $z/\delta \approx 0.14$ (for comparison with the wall-parallel PIV data). The ten sensors were separated by 0.114δ in the spanwise direction, such that the entire rake measured a spanwise domain just greater than one boundary layer thickness (see Figure 3). The probes (Dantec type 55P16) have 1.25-mm-long platinum-plated tungsten wire sensing elements of $5 \mu\text{m}$ diameter. These are operated in constant temperature mode using an AA Lab Systems AN-1003 with overheat ratio set to 1.8. Re_τ is comparable to the PIV measurements.

LARGE-SCALE STRIPINESS IN THE LOG REGION

A tendency for long streamwise regions of positive and negative u fluctuation (alternating in the spanwise direction) is immediately noticeable from the instantaneous PIV data. As an example, Figures 4 (a & b) show instantaneous streamwise velocity fluctuations from both the wall-parallel and inclined plane experiments respectively¹. These example planes are chosen for discussion on the basis that each contains different views of similar representative events. Such events are typical of many instantaneous observations. In both cases the darker shading shows negative u fluctuations. All positive fluctuations are shaded white. Figure 4 (a) is characterised by long low-speed regions, the length of which seems to exceed the measurement domain. The regions between these low speed features are typically filled by high-momentum fluid. The inclined plane data shown in Figure 4 (b) shows the typical wall-normal extent of these features. Viewed in the cross-stream direction (looking upstream), the low speed stripes of

¹It is important to note that these two frames were not acquired simultaneously. Each are from separate experiments, performed at different times.

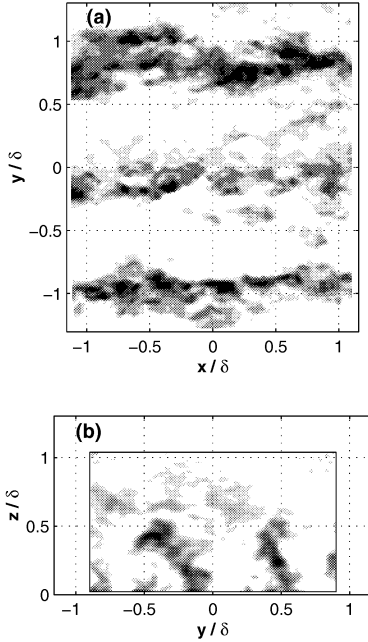

Figure 4: Example instantaneous negative u fluctuations from (a) wall-parallel and (b) 45° inclined plane PIV. Darker shading shows larger negative fluctuation. (black) $u^+ < -5$ (white) $u^+ > 0$

plot (a) appear as ‘plumes’ of low speed fluid, which in this case span from the near-wall buffer region well into the wake region (beyond 0.5δ). In this view, these features very much resemble the ‘superbursts’ discussed by Na *et al.* (2001).

The stripiness noted of Figure 4(a) has been previously reported by Ganapathisubramani *et al.* (2003) and Tomkins & Adrian (2003). Both have shown that the arrangement of swirl patches between these elongated high- and low-speed stripes is entirely consistent with the hairpin paradigm (Adrian *et al.*, 2000). When analysing in-plane swirling activity in 135° inclined plane data, Hutchins *et al.* (2005) found arrangements of vortices about low momentum ‘plumes’ (of the type noted in Figure 4b) that can also support this hairpin model. In addition to hairpin packets, other models have also been proposed to account for these features. It is probable that the ‘superbursts’ of Hanratty and coworkers are observations of similar phenomena. In a recent analysis of high Reynolds number DNS data, Jiménez & del Álamo (2004) attribute these largest-scale u fluctuations to the formation of ‘passive wakes’ from smaller attached clusters of vortices that have ejected from the buffer region. In any case, our intention here is to characterise the extent of these features, together with their scaling and any wider periodicity or organisation.

Having viewed many thousands of instantaneous realisations (such as those shown in Figure 4), the authors were immediately struck by a sense that not only is the log region populated by the large-scale u fluctuations discussed above, but that also this pattern of low-speed regions (flanked by adjacent high-speed regions) commonly repeats in the spanwise direction. Signs of such spanwise repetition are clearly evident in Figures 4(a & b).

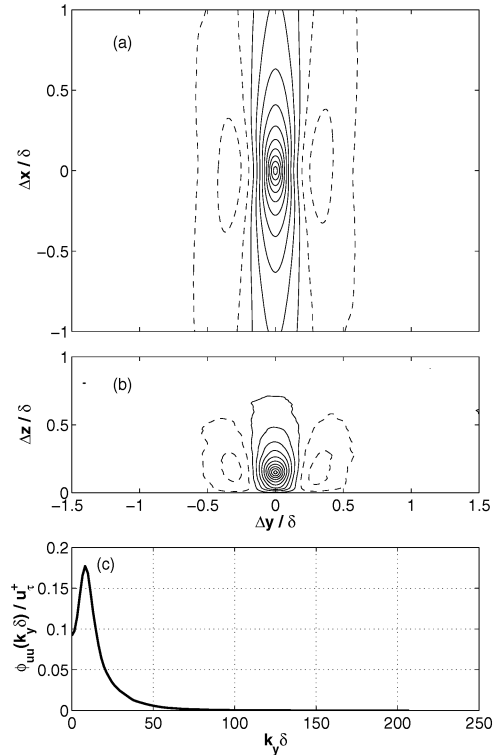

Figure 5: Two-point correlation of streamwise velocity fluctuations at $z_{ref}/\delta = 0.14$ in (a) wall-parallel and (b) 45° inclined plane. Contour levels from $R_{uu} = -0.15$ to 0.95 in increments of 0.1 (c) Pre-multiplied energy of u in the spanwise direction.

STANDARD SPANWISE STATISTICS

Figures 5(a & b) show two point correlations performed on the streamwise velocity fluctuations, at $z/\delta = 0.14$ for both the wall-parallel and 45° inclined planes. A region of strong positive correlation is flanked in the spanwise direction by anti-correlated behaviour at $\Delta y/\delta \approx \pm 0.35$. These correlated and anti-correlated regions are highly elongated in the streamwise direction such that the $R_{uu} = 0.05$ contour has an overall streamwise length of almost 4δ . The width of the positively correlated region is approximately 0.35δ , and in the wall-normal direction it spans a good portion of the wake region (beyond 0.5δ - see Figure 5b). Clearly all of the length-scale information contained within the correlation plots of Figure 5 are consistent with the structural scales we have previously noted in the instantaneous examples. The spanwise adjacent positive and negative R_{uu} behaviour reflects the tendency for spanwise alternating stripes of positive and negative u fluctuation in Figure 4. Figure 5(c) shows the energy spectra of u fluctuations in the spanwise direction (at the same wall-normal reference height $z/\delta = 0.14$). A peak occurs in the pre-multiplied spectra at $k_y\delta \approx 9$ which corresponds to a spanwise length-scale $\lambda_y \approx 0.7\delta$. This length-scale will obviously reflect the spanwise period (or wavelength) due to the positive and negative correlation regions of Figures 5(a & b). It is incorrect at this stage to interpret this peak in the pre-multiplied spectra as signifying a true spanwise periodicity. It can be shown that a single low-speed streak of width 0.35δ flanked by similar sized high-speed regions, in the absence of

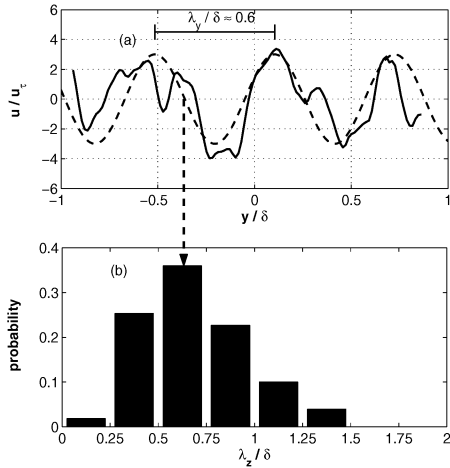

Figure 6: (a) spanwise trace of u fluctuation extracted at $z_{ref} = 0.14\delta$ (from example 45° plane shown in Figure 4b). Dashed line shows dominant spanwise Fourier mode. (b) Probability distribution of dominant spanwise wave-lengths (λ_y/δ)

any spanwise repetition of this pattern, could lead to such an energy peak. Indeed, the most obvious sign of spanwise repetition would be a spanwise ringing of the positive correlation regions of Figures 5(a & b), and such behaviour is notably absent. This raises the obvious question of why the spanwise repetition, which is so obvious in the instantaneous flow-fields, does not manifest in the time averaged statistics. The answer lies in the multitude of scales that reside in turbulent flows. The resultant statistical smearing due to a superposition of scales masks any artifact of spanwise repetition. To overcome these issues, a simple method of sorting the PIV data is proposed.

SORTING DOMINANT SPANWISE ENERGY MODES.

The sorting method is illustrated in Figure 6 and summarised by the following procedure.

- A spanwise trace of streamwise velocity fluctuation is extracted from each frame at a given reference height. The solid line in Figure 6(a) shows the signal extracted from the example frame of Figure 4(b) at $z_{ref} = 0.14\delta$.
- Fourier analysis of the extracted signal reveals the dominant spanwise mode in that particular frame (see dashed sinusoid in Figure 6a).
- The frame is sorted or ‘binned’ according to the dominant mode (λ_y). The case shown in Figure 6a is added to the $\lambda_y/\delta = 0.5 - 0.75$ bin (see arrow).
- Two point correlations are conducted on the ‘binned’ (or de-jittered) sets of frames.

The probability distribution for the sorted frames is shown by Figure 6(b). For the relatively broad bin sizes used here (0.25δ increments from 0 to 1.5), it is found that most of the energy resides in 4 modes, with $0.5 < \lambda_y/\delta < 0.75$ being the most populated bin. Of the entire data-set, 37% of all frames exhibit a dominant spanwise u fluctuation of this wavelength. The two-point correlations as calculated on these four dominant modes are shown in Figure 7 plots (a - d). Note that

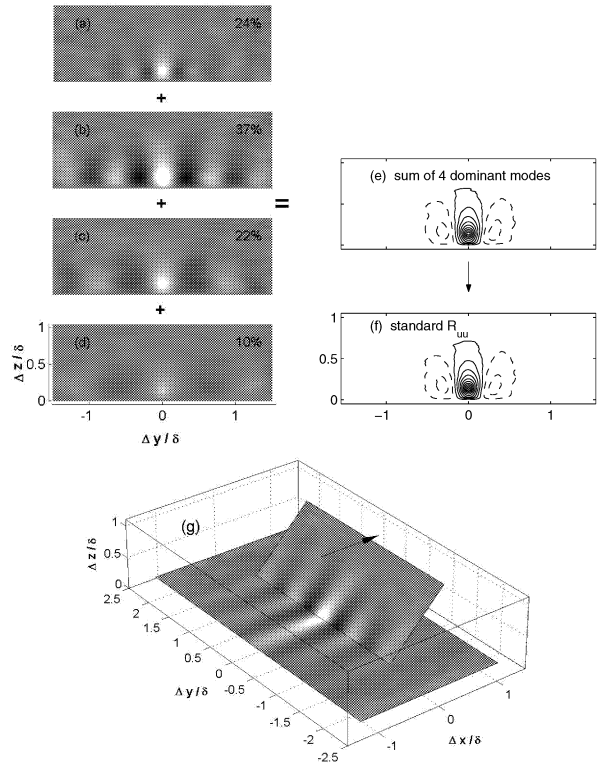

Figure 7: R_{uu} calculated at $z_{ref} = 0.14\delta$ for each of the four dominant modes (a) $0.25 < \lambda_y/\delta < 0.5$; (b) $0.5 < \lambda_y/\delta < 0.75$; (c) $0.75 < \lambda_y/\delta < 1.0$; (d) $1.0 < \lambda_y/\delta < 1.25$. (e) shows the sum of these four modes as compared to (f) the standard R_{uu} . (g) R_{uu} calculated for $0.5 < \lambda_y/\delta < 0.75$ mode for both wall-parallel and 45° inclined plane data.

these modes recover 93% of the total energy (93% of all PIV frames exhibit these spacing modes). With the data sorted in this way, there is clear evidence of ringing in the ‘binned’ two-point correlations indicating an underlying spanwise periodicity. This is perhaps expected along the line $z = z_{ref}$ (due to the sorting condition), but the fact that these spanwise modes extend a considerable distance in the wall-normal direction ($> 0.5\delta$) implies a far wider coherence. Note that this is raw unfiltered data. Yet 93% of all frames are well described by a single sinusoidal mode for all of the log region and slightly beyond (up to 0.5δ). Figure 7(e) shows the sum of the 4 dominant modes (plots a + b + c + d). Despite the fact that repeating modes characterise the majority of the data, the superposition of the individual modes leads to an R_{uu} plot that exhibits no obvious sign of spanwise periodicity. The sum of the 4 dominant modes shown in plot (e) almost completely recovers the standard R_{uu} profile (included for comparison as plot f). This is a graphic illustration of the caution that should be exercised when interpreting statistical quantities such as R_{uu} , where multiple scale interactions and superposition can mask underlying organisation. The same de-jittering process has been applied to the wall parallel data set revealing the streamwise extent of these dominant modes. Figure 7(g) shows the R_{uu} construct from the most populated bin ($0.5 < \lambda_y/\delta < 0.75$) for both the wall-parallel and inclined plane PIV data sets. Clearly the previously observed

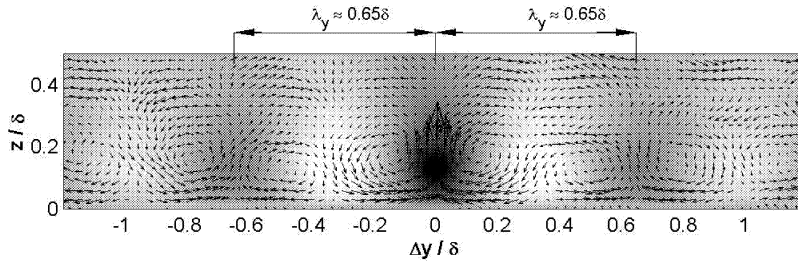

Figure 8: LSE conditioned on a negative u event at $z/\delta = 0.14$. Only frames which exhibit a dominant spanwise length-scale $0.5 < \lambda_y/\delta < 0.75$ are included in the estimate (37% of frames from the 45° inclined plane data set). Gray-scale shows velocity fluctuations (dark) low momentum region $-u$ (light) high momentum region $+u$. Vectors show conditioned v and w components.

spanwise modes actually persist for a substantial distance in the streamwise direction, extending well beyond the $x = \pm\delta$ view afforded by the PIV data.

Thus far the ‘binned’ data have just been analysed in terms of two-point correlations (on the streamwise velocity component u). In practise, we are free to employ other statistical techniques on the sorted data sets to reveal additional details of the underlying spanwise periodic structure. As an example Figure 8 shows a Linear Stochastic Estimation calculated on the most populous bin. In this case the condition event is a low-speed u fluctuation at $z_{ref} = 0.14\delta$. For this simple detection criteria, the LSE is essentially a function of the two-point correlation tensors R_{uu} , R_{uv} and R_{uw} (see Adrian & Spalart 1988 and Tomkins & Adrian 2003 for an explanation of the LSE technique). The gray shading shows the u fluctuation associated with the condition event. As expected from the two-point correlations of Figure 7, the negative signed condition event (darker shading), is flanked at approximately $\pm 0.35\delta$ by high-speed events (lighter shading). This pattern repeats in the spanwise direction with a wavelength that is consistent with the bin under consideration. The vectors plotted over the top of the gray-scale show the spanwise and wall-normal velocity fluctuation associated with the negative u conditional event. Clearly, in a time averaged sense, there is a wider structure associated with these large-scale modes. The low-speed condition event is actually an ejecting motion, whilst the flanking behaviour is characterised by sweep. The vectors reveal common-flow-up arrangements of counter-rotating vortices associated with the low-speed streaks. This pattern also repeats about the dominant mode ($\Delta y \pm 0.65\delta$), such that three counter-rotating pairs are visible in Figure 8. It is always wise to exercise caution when drawing conclusions from conditional averages. Figure 8 is after all just the statistical imprint left on the two-point correlations by a conditional event. There is always a danger in extrapolating time averaged structures to instantaneous flow-fields. However, these LSE results would seem to imply that there is a wider vortical activity (or at least an intrinsic v and w fluctuation) associated with the stripiness in u noted of Figure 4.

HOT-WIRE DATA

Having established evidence for a spanwise organisation, we set out to explore the true streamwise length of the stripiness observed in the wall-parallel plane u fluctuations. Clearly in Figure 4(a), the length of these features exceeded the PIV viewing window. The idea here is to use the fluctuating signals

from the ten hot-wire probes to reconstruct the instantaneous spanwise profile of the u velocity fluctuation. By projecting this signal in time and using Taylor’s Hypothesis (frozen convection) a view of the long high- and low-speed streaks can be constructed that covers a much larger streamwise domain than that available with PIV. An example section of the reconstructed field is shown in Figure 9(a). The gray shading shows only the negative fluctuations. Positive fluctuations are shaded white (see scale). A typical size PIV vector field for this Reynolds number is shown as plot (b). Clearly there are some very long features in the flow that the PIV data will fail to adequately capture. A long, meandering low-speed region wanders through the measurement domain for the entire 14δ shown. Indeed when we run movies of the frozen turbulence as it advects past the probe array, there are many instances where the length of the streaks exceeds 20δ . There is a problem that the meandering often causes the streak to leave the spanwise limit of the domain ($y/\delta = \pm 0.5$). This tends to curtail the maximum length of streaks that we can track.

Kim & Adrian (1999) and del Álamo & Jiménez (2003) found streamwise energy residing at comparable length-scales for pipe and DNS channel flows. Figure 9(c) shows streamwise fluctuations from the channel flow simulations at $Re_\tau = 940$ and $z/\delta = 0.14$ (del Álamo *et al.*, 2004 give simulation details). Clearly the numerical simulations exhibit a similar spanwise stripiness in the u fluctuations, with evidence of very long streamwise features. Our own hot-wire rake experiments were recently repeated in a much larger high Reynolds number boundary layer facility at the University of Melbourne (up to $Re_\tau = 20000$, see Hafez *et al.* 2004 for details of facility). Data from these studies are still under analysis. However, initial results clearly indicate that the same long features, with a streamwise length that commonly exceeds 15δ , populate the log region of these higher Reynolds number flows².

The autocorrelation curve for u fluctuations in the log region, tends to fall to zero, actually becoming slightly negative for signal shifts $\Delta x \gtrsim 4\delta$. The broad peak in the pre-multiplied streamwise spectra $k_x \Phi_{uu}$ occurs for similar length-scales. Such features in classical single point statistics have previously informed our view of the largest energetic scales in turbulent boundary layers. However the rake data, and in particular velocity maps such as those shown in Figure 9 (a), demonstrate that much larger scales inhabit the flow. It is proposed that these length-scales are not resolved by classical single point techniques due to a spanwise wandering or me-

²In the Melbourne wind tunnel, 15δ equates to a physical length-scale of approximately 5m for the largest u fluctuations

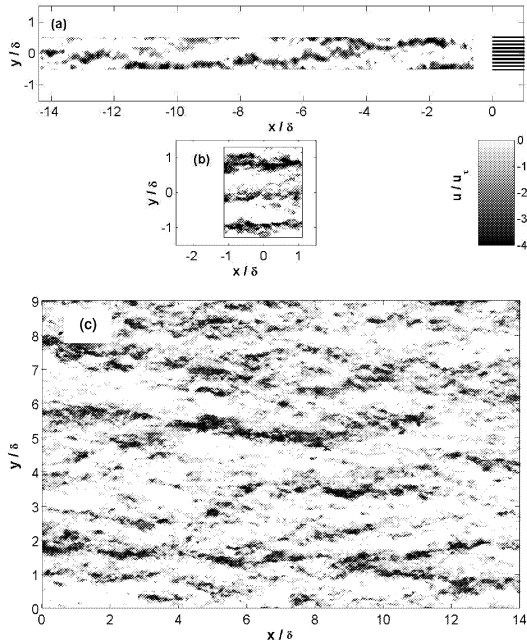

Figure 9: (a) Example signal section from ten sensor hot-wire rake at $z/\delta = 0.14$. Spatial view is reconstructed using local mean velocity ($x = -U_c t$). Shading shows negative u fluctuations only (see colour scale); (b) comparison with typical PIV frame; (c) negative fluctuations from $Re_\tau = 940$ DNS data at same wall normal location.

andering in the streaks. Further evidence of this meandering is presented in Hutchins *et al.* (2004), where it is shown that a fake flow-field comprised just of meandering low- and high-speed streaks can successfully recreate the salient features of the two-point correlation map R_{uu} (especially unusual correlation behaviour that occurs at $\Delta x \approx \pm 3.5\delta$).

CONCLUSIONS

An analysis of the largest scale features in the log region of a turbulent boundary layer has lead to the following conclusions:

- Instantaneous spanwise u behaviour is well described by single spanwise sinusoidal modes extending a considerable distance in the wall-normal and streamwise directions
- There is a strong spanwise periodicity associated with the largest streamwise velocity fluctuations. Since, these velocity fluctuations are indicative of a wider vortical structure, such results would seem to have implications to flow control / prediction strategies, and may hold clues to the underlying structural dynamics.
- These large-scale features are extremely long in the streamwise direction (occasionally $> 20\delta$) and seem to meander appreciably. The meandering effectively hides the true length of these features from single point measurement techniques.

The authors gratefully acknowledge support from the National Science Foundation (Grant CTS-0324898) and the David and Lucile Packard Foundation. The authors also thank Professor Moser for making the $Re_\tau = 940$ DNS database available.

REFERENCES

- ADRIAN, R. J., MEINHART, C. D. & TOMKINS, C. D. 2000 Vortex organization in the outer region of the turbulent boundary layer. *J. Fluid Mech.* 422, 1–54.
- ADRIAN, R. J. & SPALART, P. 1988 Stochastic estimation of organized turbulent structure: homogeneous shear flow. *J. Fluid Mech.* 190, 531–559.
- DEL ÁLAMO, J. C. & JIMÉNEZ, J. 2003 Spectra of the very large anisotropic scales in turbulent channels. *Phys. Fluids* 15, 41–44.
- DEL ÁLAMO, J. C., JIMÉNEZ, J., ZANDONADE, P. & MOSER, R. D. 2004 Scaling of the energy spectra of turbulent channels. *J. Fluid Mech.* 500, 135–144.
- GANAPATHISUBRAMANI, B., HUTCHINS, N., HAMBLETON, W. T., LONGMIRE, E. K. & MARUSIC, I. 2005 Investigation of large-scale coherence in a turbulent boundary layer using two-point correlations. *J. Fluid Mech.* 524, 57–80.
- GANAPATHISUBRAMANI, B., LONGMIRE, E. K. & MARUSIC, I. 2003 Characteristics of vortex packets in turbulent boundary layers. *J. Fluid Mech.* 478, 35–46.
- HAFEZ, S., CHONG, M. S., MARUSIC, I. & JONES, M. B. 2004 Observations on high Reynolds number turbulent boundary layer measurements. In *Proceedings of the Fifteenth Australasian Fluid Mechanics Conference* (ed. M. Behnia, W. Lin & G. D. McBain).
- HEAD, M. R. & BANDYOPADHYAY, P. 1981 New aspects of turbulent boundary-layer structure. *J. Fluid Mech.* 107, 297–337.
- HUTCHINS, N., GANAPATHISUBRAMANI, B. & MARUSIC, I. 2004 Dominant spanwise Fourier modes, and the existence of very large scale coherence in turbulent boundary layers. In *Proceedings of the Fifteenth Australasian Fluid Mechanics Conference* (ed. M. Behnia, W. Lin & G. D. McBain).
- HUTCHINS, N., HAMBLETON, W. T. & MARUSIC, I. 2005 Inclined cross-stream stereo PIV measurements in turbulent boundary layers. *J. Fluid Mech.* Submitted.
- JIMÉNEZ, J. & DEL ÁLAMO, J. C. 2004 Computing turbulent channels at experimental Reynolds numbers. In *Proceedings of the Fifteenth Australasian Fluid Mechanics Conference* (ed. M. Behnia, W. Lin & G. D. McBain).
- KIM, K. C. & ADRIAN, R. J. 1999 Very large scale motions in the outer layer. *Phys. Fluids* 11, 417–422.
- KLINE, S. J., REYNOLDS, W. C., SCHRAUB, F. A. & RUNDSTADLER, P. W. 1967 The structure of turbulent boundary layers. *J. Fluid Mech.* 30, 741–773.
- MCLEAN, I. R. 1990 The near-wall eddy structure in an equilibrium turbulent boundary layer. PhD thesis, University of Southern California, USA.
- NA, Y., HANRATTY, T. J. & LIU, Z. 2001 The use of DNS to define stress producing events for turbulent flow over a smooth wall. *Flow Turbul. Combust.* 66, 495–512.
- ROBINSON, S. K. 1991 Coherent motions in turbulent boundary layers. *Annu. Rev. Fluid Mech.* 23, 601–639.
- TOMKINS, C. D. & ADRIAN, R. J. 2003 Spanwise structure and scale growth in turbulent boundary layers. *J. Fluid Mech.* 490, 37–74.
- WARK, C. E., NAGUIB, A. M. & ROBINSON, S. K. 1991 Scaling of spanwise length scales in a turbulent boundary layer. *AIAA-paper* 91-0235, 29th Aerospace Sciences Meeting, Reno, Nevada.